

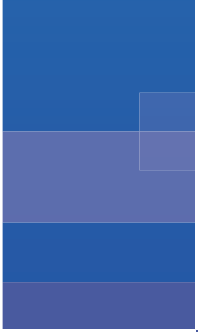

Stareast International Pty Ltd

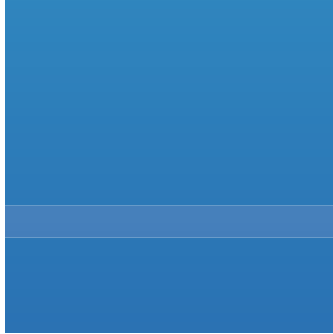

# Catalogue & Information Guide 2014



## Stareast International Pty Ltd

Stareast International is a family owned business that has successfully supplied our customers with reliable parts and equipment for over 40 years.

We supply and sell spare parts and tools for a wide range of refrigeration units including, industrial, commercial and domestic refrigeration, washing machine, electrical stove, hot water and air conditioning systems for both the domestic and commercial markets.

Our Group has now significantly broadened its technical strength and now offers refrigeration engineering solutions with specialised equipment selections and innovative refrigeration solutions to suit your specific needs.

We provide a complete package of consistent engineered technical expertise, training assistance and competitive pricing to our customers - by utilising the highest quality supply partners.

Our aim is to give you prompt customer service and a workable solution that will in turn meet you and your client's particular needs.

We invite you to test us out and deal with a professional trust worthy company. Join us and discover the difference.

### PROUD PARTNERS WITH:

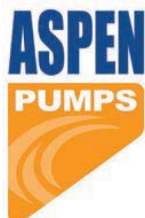

# We are here to help GROW YOUR BUSINESS

## Emerson Climate Technologies

The world's leading provider of first class heating, ventilation, air conditioning and refrigeration solutions for residential, industrial, and commercial applications. Emerson Climate Technologies brings you Technology Day. A grand and important showcase of our superior product brands and complete streak of services to help your business think and grow all the way up!

## Our Brands

We offer nothing but the best value of products, services, and integrated solutions to our customers around the world.

<b>Copeland™</b> brand products	<b>Refrigeration and HVAC controls</b>	<b>Flow Controls</b>
<ul style="list-style-type: none"> <li>• Residential and Commercial Air Conditioning</li> <li>• Compressors</li> <li>• Commercial Refrigeration</li> <li>• Compressor Electronics</li> <li>• Condensing Units</li> <li>• Semi-Hermetic Compressors</li> </ul>	<ul style="list-style-type: none"> <li>• Electronic Controls</li> <li>• Refrigeration</li> <li>• Air Conditioning</li> <li>• Time/Temperature/ Humidity Pressure</li> <li>• General Applications</li> <li>• Systems</li> <li>• Probes</li> <li>• Accessories</li> </ul>	<ul style="list-style-type: none"> <li>• Thermal Expansion Valves</li> <li>• Solenoid Valves and Coils</li> <li>• System Protectors</li> <li>• Temperature Pressure Controls</li> <li>• Oil Controls</li> <li>• Shut Off Valves</li> <li>• Electronic Expansion Valves and Controls</li> </ul>

## Our Programs

 **Jumpstart E Support Tools**  
Mobile tools for cross referencing, unit conversion and product selection



Select Asia



Component Configurator



PT Pro



Compressor/CDU Replacement Tool



X-Check

Need to get an access? Register at  
[www.EmersonClimate.com/PartnerPlusToolKitRegistration](http://www.EmersonClimate.com/PartnerPlusToolKitRegistration)

 **Emerson Climate Technologies Partner+ Services**  
A service program geared towards helping its members address today's HVACR needs. It provides:



Product Technical Support



Project Design Guidance



Education & Training



Service Center

To learn more, register at [www.EmersonClimate.com/PartnerPlus](http://www.EmersonClimate.com/PartnerPlus)

**Get Engaged! Talk to us today!**





**6 - 7**  
Coregas PARTNER, Emerson PARTNER, Alco Products

**8-9**  
Emerson IZSI Condensing Unit

**10 -11**  
Greenhalgh E2 Evaporator

**12 - 15**  
Emerson Copland Fractional Data Sheets and Infomration

**16 -17**  
Emerson Alco Expansion valves Orifice Assembly Data Sheets

**18 -19**  
Emerson Alco Driers  
Emerson Pressure Controls, LP, etc

**20-21**  
Soft Drawn Copper Tube  
Hard Drawn Copper Tube  
Pair/Twin Coil  
Colourbond Trunking  
Wall/Roof Brackets  
Rubber Feet, Copper Saddles  
Pipe Supports & Channels

**22-23**  
PVC Fittings, Fire Rated Inso Pipe

**24-25**  
Universal Remotes & PC Boards  
Condensate Drains/PUMPS

Copper Elbows  
Copper Tees  
Copper Couplings

**26-27**  
Short Barrell Flare Nuts  
P-Traps, copper  
Brass Flare T-Unions  
Brass Flare Unions  
Frost Proof Flare Nuts  
Pipe Plugs  
Brass Connectors

**28-29**  
Start Capacitors  
Square A/C Capacitors  
Oval Twin Capacitors  
Oval Capacitors, Run Capacitors  
Twin Round Capacitors  
Mapp & Oxy Sets

**30-31**  
BLACK DIAMOND TOOLS  
Reclaim Units  
Vacuum Pumps, Oil & Vacuum  
Gauges  
Tube Benders  
Brass Vacuum fittings, adaptors

**32-33**  
Tube Expanders (Swaging)  
Spring Benders, UV dye Kits  
Tube, Pipe & Hose Cutters, Hoses  
JB Manifold Gauges, Leak Detectors

**34-35**  
Flaring, Swaging & Deburring Tools  
Equipment, Inspection Mirrors

**36-37**  
Multimeters & Amprobe Meters  
Other Testers , Clamp Meters

**38-39**  
Tools, Toilet, Terminal Kits, Tool  
bags, Vacuum pump oil, flushing.

**40-41**  
Electrical Tape, glue, solvents,  
cleaners, foams, paints etc

**42-43**  
Compressors  
Domestic, Commercial, Pan heaters  
kits compressor.

**44-45**  
Condensing units,  
Condensors, TX valves,  
HP/LP,  
Solenoid,  
Service valves  
Orifices

**46-47**  
valves, cpr,epr, check, relief  
Driers,  
Site Glass  
Rotalocks

**48-49**  
Axial Fans, Blades  
Valves, oil seperators  
Driers, Suction Accumulators  
Vibration Eliminators

**50-51**  
Digital Timers, Thermometers and  
Controls  
Generic Controls and Boxes

**52-53**  
Digital Thermometers,  
Timers & Controls  
Programmable Evaporator motors  
Timers DOM, DOB  
Domestic Defrost timers

**54-57**  
Shaded Pole evaporator motors  
Condensor Fan Motors  
Evaporator Motors  
Bullet Valves  
Relay's & Overloads, 3 in 1.  
Fan Controls, Contactors,

**58-59**  
Relay's  
Contactors. Overloads  
Brazing, Flux  
Capillary Tubing  
Domestic Heating Elements

**60-61**  
Refrigeration Heating Elements  
PVC Heaters  
Refrigeration Thermostats Domestic

**62-64**  
Thermostats  
Refrigeration Door Switches  
Defrost Termination

**65-67**  
Water Filters, Ice Maker Valves and  
Hook-up Kits, Globes/Lamps  
Coolroom Hinges and Latches  
speedfit fittings,  
Core Tools remover  
Circuit Breakers, Isolators, Enclo-  
sures, Heat Sinks, Time Clocks

**68-71**  
Limit Switches  
Time Clocks  
Box Enclosures  
Square Sockets  
Plugs and Sockets  
Gewiss Floor Boxes  
Buzzers and Bells  
Sirens  
Strobe Lights  
Tend Isolators,  
Thermostats- Din Mounted  
Wire Guards,  
Heaters- Din Mounted  
Porcelain Terminal Blocks  
Nylon Cable Glands  
Aixial Fan 350 technical Data Sheet



# HEATING & ELECTRICAL

72 - 94

72

Hot Water Elements  
 Heavy Duty  
 MP Elements  
 Hard/All Water  
 Hot Water thermostats

73-83

PTR Relief Valves  
 Thin Coil Elements  
 Monotube Elements  
 Solid Hotplates  
 Glass Top Hilight Elements  
 Rings and Sockets  
 Sockets  
 Bowls and Pans  
 Fan Motors and Accessories  
 Fan Forced Oven Elements  
 Oven and Grill Elements

84-88

Door Hinges  
 Thermostats

89-92

Controls  
 Switches and Indicators  
 Terminals and Connectors

93-94

Gas cooktop specific parts  
 Thermocouples  
 Igniters  
 Knobs and Other Accessories

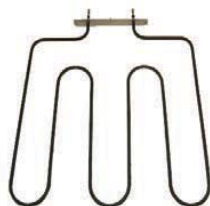

# GENERAL APPLIANCE SPARES

95 - 115

95

F & P Generic Parts

96-97

Whirlpool Parts  
 Maytag Parts

98-101

Dishwasher Parts  
 Dryer Parts

102 - 104

Belts  
 Universal Door Interlocks  
 Motor Brushes

105 - 108

Pumps (Washing Machine & Dishwasher)

109 - 111

Kleenmaid parts  
 GE Parts  
 LG Parts  
 Universal Parts and Accessories

112-113

Hoses, Clamps and Connectors  
 Inlet hoses  
 outlets hoses

114-115

Water Inlet Valves  
 Universal Bearings  
 Miscellaneous





Introducing Coregas - the largest Australian owned industrial, medical and specialty gas company. Coregas are proud to say that service and quality are at the core of everything.

Gases range from those commonly used such as oxygen and nitrogen, and now refrigerants, to the rarest of gases like krypton, but it is Coregas service and guaranteed quality of these gases that sets Coregas apart.

Visit coregas at

<http://www.coregas.com.au/>

#### REFRIGERANTS & CYLINDERS



#### CYLINDERS

CYL-GAS1	11KG CAPACITY DUAL VALVE 5.2MPA, White
CYL-GAS2	22KG CAPACITY DUAL VALVE 5.2MPA White
CYL-GAS3	10-12KG CAPACITY SINGLE VALVE
CYL-GAS4	46KG CAPACITY DUAL VALVE 5.2MPA White
CYL-GAS5	40KG CAPACITY DUAL VALVE
CYL-GAS6	12KG CAPACITY DUAL VALVE
CYL-GAS7	12KG CAPACITY SINGLE VALVE R410A
RF970	Valve dual 5.2mpa spare part for cylinder up to 45kg

#### REFRIGERANT

R410A	HFC blend 50% HFC 32, 50% HFC 125
R134A	HFC 134a 1,1,1,2 Tetrafluoro- ethane
R404A	HFC blend 52% HFC 143a, 44% HFC 125, 4% HFC 134a
R22	HCFC 22 Chlorodifluoromethane
R407C	HFC blend 23% HFC32, 25% HFC 125, 52% HFC 134a

#### INDUSTRIAL GASES

SENITRO	NITROGEN CYLINDER C SIZE
SEOXYGEN	OXYGEN CYLINDER C SIZE
SEACET	ACETYLENE CYLINDER C SIZE
RFGTAR2	ARGON
RFGTARC102	ARGON/CO2 (10%)
RFGTAROX2	ARGON/O2 (2%)
RFGTNI2	NITROGEN (FOOD GRADE)
RFGTHE2	HELIUM
RFGTCD22	CO2 (FOOD GRADE)

## Coregas for Gases and Equipment

Coregas provides a complete range of gases and equipment for:

- industrial applications
- specialty applications
- refrigeration applications
- health care
- liquefied and process gas applications

From single cylinders in a range of sizes, to on site vessels and specially designed installations, Coregas' specialty is providing the right gas, in the volume and frequency you require plus the equipment to work with it.

With over 38 years' experience in the Australian market, you can be sure of Coregas' quality, reliability and technical expertise.

### Industrial gases

The Coregas industrial range comes in a range of cylinder sizes and includes:

- Oxygen - uses include cutting, welding, brazing and soldering. In combination with acetylene, it produces the hottest flame temperature for welding.
- Acetylene - uses include welding, brazing, texturing, profile cutting and spot heating applications.
- Nitrogen - uses include inerting and purging vessels, tanks and pipelines, blanketing, sparging and pressure transfer of liquids.
- Carbon dioxide - uses include cooling, inerting, and in fire extinguishers for electrical and oil fires.

### Refrigerants

Coregas supply refrigerants in bulk vessels. For any projects or applications please contact [alan@stareast.com.au](mailto:alan@stareast.com.au) or call 02 9792 5988 with your request.

No project is too small, no project is too big. We have what it takes to get the application complete.



**RFTE531** OPTION ON ALL CYLINDERS, THIS GREAT TAMPER EVIDENT STRAP WILL STOP THE REFRIGERANT FROM DISAPPEARING INTO THE WRONG HANDS.....



**RF162A** GAS CAP, GREAT IDEA TO SEAL YOUR CYLINDERS ALWAYS.



Alco Controls

*To control refrigeration, air conditioning and heating systems Emerson Climate Technologies offers a broad range of expansion valves, filter driers, solenoid valves, oil management products, pressure transducers, thermostats, etc. All components of Alco Controls, mechanical as well as electronic, are designed and manufactured to ensure maximum efficiency and reliability. Optimizing system performance is central to Alco Controls developments.*

*FOR more information sign up to Emerson Partner Plus, ask one of our staff for assistance.*

EM802463	TIS-SW INTERNALLY EQUALIZED
EM802425	TISE-HW EXTERNALLY EQUALIZED 1/2"
EM802450	R134a TISE-MW EXTERNALLY EQUALIZED 1/2"
EM802464	TISE-SW EXTERNALLY EQUALIZED
EM802420	TI-HW INTERNALLY EQUALIZED 1/2"
EM802445	R134a TI-MW INTERNALLY EQUALIZED 1/2"
EM802459	R404a TI-SW INTERNALLY EQUALIZED 1/2"
EM802445	R22 TIE-HW EXTERNALLY EQUALIZED 1/2"
EM802446	R134a TIE-MW EXTERNALLY EQUALIZED
EM802460	R404a/R507 TIE-SW EXTERNALLY EQUALIZED
EM800532	TIO-00X ORIFICE
EM800533	TIO-000 ORIFICE
EM800534	TIO-001 ORIFICE
EM800535	TIO-002 ORIFICE
EM800536	TIO-003 ORIFICE
EM800537	TIO-004 ORIFICE
EM800538	TIO-005 ORIFICE
EM800539	TIO-006 ORIFICE
EM060967	A-AS 464 SUCTION ACCU 1/2"

EM060821	A-AS 465 SUCTION ACCU 5/8"
EM060824	A-AS 596 SUCTION ACCU 3/4"
EM060818	A-AS 597 SUCTION ACCU 7/8"
EM060933	A-W55824 1/2 ODF OIL SEP
EM060934	A-W55855 5/8 ODF OIL SEP
EM060931	A-W55877 7/8 ODF OIL SEP
EM801210	110RB2 T2 1/4" SOLENOID VALVE
EM801190	200RB4 T3 3/8" SOLENOID VALVE
EM801178	200RB4 T4 1/2" SOLENOID VALVE
EM064952	OIL FILTER SAE 3/8" FLARE AOF 303
EM062784	OIL FILTER 3/8" ODF SOLDER AOF 023S
EM064799	F023 CARTRIDGE
EM801064	ASC 230V COIL
EM801062	ASC 24V COIL
EM097456	FS113ZU - OIL CONTROL
EM436100	PS2-M7A
EM4370700	PS1-A3A LP ALCO CONTROL -0.5-7 BAR
EM4350500	PS1-A5A HP ALCO CONTROL 6-30 BAR
EM047601	LIQUID LINE FILTER-DRIER 1/4" FLARE EK 052
EM047602	LIQUID LINE FILTER-DRIER 1/4" SOLDER EK 052S
EM047607	LIQUID LINE FILER-DRIER 3/8" FLARE EK 083
EM047608	LIQUID LINE FILER-DRIER 3/8" SOLDER EK 083S
EM065405	MOISTURE INDICATOR HMI - 1TT2
EM065406	MOISTURE INDICATOR HMI - 1TT3
EM806750	BALL VALVE 1/4" SOLDER BVS 014
EM806752	BALL VALVE 3/8" SOLDER BVS 038
EM805201	COMPRESSOR SOFT STARTER 25A 230VAC CSS 25U
EM805200	COMPRESSOR SOFT STARTER 32A 230VAC CSS 32U
EM802424	TIS-HW INTERNALLY EQUALIZED
EM802449	TIS-MW INTERNALLY EQUALIZED



COREGAS PARTNER, EMERSON PARTNER, REFRIGERATION

## World Leader in Scroll Compressor Technology

Emerson Climate Technologies introduced a new phase of energy efficiency for the HVACR industry 25 years ago with the launch of Copeland Scroll™ technology in 1987. By 1992, the company had produced one million Copeland Scroll compressors.

Today, Emerson is the world's largest manufacturer of air-conditioning and refrigeration scroll compressors with over 100-million scroll compressors installed worldwide. Leveraging Emerson's vast global network and R&D resources, the company continues to innovate and invest in climate solutions that help improve human comfort, minimize the environmental impact, and ensure food quality.

## Introducing IZSI R22 and R404A Models for Low and Medium Temperature Application Condensers

### Wide Operating Envelope for Various Applications

- Robust and efficient operation from -30°C to 5°C evaporating temperature
- Suitable for application ranging from Low Temperature and Medium Temperature cold rooms to Medium Temperature showcases

### Efficient and Quiet – Key Scroll Attributes

- COP improvement leads to higher annual electrical savings as compared compared to systems with reciprocating compressors
- Low sound and vibration leading to quieter operation
- No complex internal suction and discharge valves for higher reliability

### Low Applied Cost – Completely Factory Built

- IZSI comes with factory installed accessories (e.g. liquid line filter drier, sight glass/moisture indicator, liquid line solenoid valve, electrical contactor) thus simplifying component sourcing

### Simple and Reliable – Powered by Copeland Scroll with CoreSense™

- Liquid Injection Technology – controlled by CoreSense – manages discharge temperature for maximum performance and reliability
- CoreSense can detect and display sensor failure through its LEDs enabling easier troubleshooting
- Copeland Scroll compressors have fewer moving parts than reciprocating compressors, thus making it more reliable
- Consistent quality achieved through factory built Condensing Unit

## Performance Data

### R22

Condensing Unit Model		SEI/IZSI06A	SEI/IZSI08A	SEI/IZSI09B	SEI/IZSI11B	SEI/IZSI14C	SEI/IZSI15C	SEI/IZSI18D
Compressor Model		ZSI06KQ	ZSI08KQ	ZSI09KQ	ZSI11KQ	ZSI14KQ	ZSI15KQ	ZSI18KQ
LT Cold Room	Capacity	2.04	2.35	2.55	3.60	4.18	4.81	5.97
	Power	1.64	2.03	2.03	2.49	2.95	3.37	4.01
	COP	1.24	1.15	1.26	1.35	1.42	1.43	1.49
MT Showcase	Capacity	3.56	4.15	4.70	5.81	7.36	8.14	10.37
	Power	1.81	2.26	2.25	2.79	3.48	4.02	4.66
	COP	1.97	1.84	2.09	2.08	2.11	2.02	2.22
MT Cold Room	Capacity	4.23	4.89	5.63	6.92	8.72	9.59	12.25
	Power	1.86	2.33	2.32	2.93	3.66	4.25	4.93
	COP	2.28	2.10	2.43	2.36	2.39	2.25	2.49

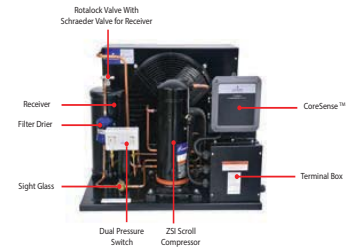

### R404A

Condensing Unit Model		SEI/IZSI06AE	SEI/IZSI08AE	SEI/IZSI09BE	SEI/IZSI11BE	SEI/IZSI14CE	SEI/IZSI15CE	SEI/IZSI18DE
Compressor Model		ZSI06KQE	ZSI08KQE	ZSI09KQE	ZSI11KQE	ZSI14KQE	ZSI15KQE	ZSI18KQE
LT Cold Room	Capacity	2.25	2.59	3.05	3.66	4.59	5.15	6.63
	Power	1.82	2.20	2.23	2.58	3.21	3.61	4.37
	COP	1.23	1.18	1.37	1.42	1.43	1.43	1.52
MT Showcase	Capacity	3.86	4.43	5.17	6.29	7.90	8.67	11.07
	Power	1.99	2.42	2.46	2.93	3.77	4.28	5.22
	COP	1.94	1.83	2.10	2.14	2.10	2.03	2.12
MT Cold Room	Capacity	4.53	5.18	6.03	7.37	9.24	10.08	12.86
	Power	2.05	2.49	2.55	3.07	3.96	4.58	5.51
	COP	2.21	2.08	2.36	2.40	2.33	2.20	2.33



Notes: 1. Conditions are rated as follows:  
 - Return Gas Temp. (°C): 18.33  
 - Subcooling (°C): 2.77  
 - LT Cold Room -25°C Evaporating Temperature / 32°C Ambient  
 - MT Showcase -10°C Evaporating Temperature / 32°C Ambient  
 - MT Cold Room -5°C Evaporating Temperature / 32°C Ambient  
 2. Units are in Kilowatts (kW) for Capacity and Power and W/W for COP

A CLASS TECHNOLOGY. MATCH AN IZSI TO A GREENHALGH EVAPORATOR. FOR ASSISTANCE SIGN UP TO PARTNER PLUS TODAY!



## Technical Data

### R22

Condensing Unit Model	SEI/IZSI06A	SEI/IZSI08A	SEI/IZSI09B	SEI/IZSI11B	SEI/IZSI14C	SEI/IZSI15C	SEI/IZSI18D
Electrical Code	PFZ		TFM		TFM		TFM
Compressor Model	ZSI06KQ	ZSI08KQ	ZSI09KQ	ZSI11KQ	ZSI14KQ	ZSI15KQ	ZSI18KQ
Chassis	A		B		C		D
Receiver (Liter)	2.5		5.0		5.0		7.0
Chassis WxDxH (mm)	Single Fan		735 x 680 x 533		735 x 680 x 533		-
	Dual Fan		-		-		1020 x 680 x 560
Phase - Hz	1 Phase - 50 Hz		3 Phase - 50 Hz		3 Phase - 50 Hz		3 Phase - 50 Hz
Rated Voltage (Volts)	220-240		380-420		380-420		380-420
Unit LRA (Amperes)	57.0	72.0	40.0	52.0	52.0		74.0
Unit RLA (Amperes, MCC/1.44)	11.0	12.0	5.0	7.1	7.8	8.4	9.5
Net Weight (kg, including oil)	65.0		70.0	78.0	80.0		85.0
Oil Type	Mineral Oil		Mineral Oil		Mineral Oil		Mineral Oil

### R404A

Condensing Unit Model	SEI/IZSI06AE	SEI/IZSI08AE	SEI/IZSI09BE	SEI/IZSI11BE	SEI/IZSI14CE	SEI/IZSI15CE	SEI/IZSI18DE
Electrical Code	PFZ		TFM		TFM		TFM
Compressor Model	ZSI06KQE	ZSI08KQE	ZSI09KQE	ZSI11KQE	ZSI14KQE	ZSI15KQE	ZSI18KQE
Chassis	A		B		C		D
Receiver (Liter)	2.5		5.0		5.0		7.0
Chassis WxDxH (mm)	Single Fan		735 x 680 x 533		735 x 680 x 533		-
	Dual Fan		-		-		1020 x 680 x 560
Phase - Hz	1 Phase - 50 Hz		3 Phase - 50 Hz		3 Phase - 50 Hz		3 Phase - 50 Hz
Rated Voltage (Volts)	220-240		380-420		380-420		380-420
Unit LRA (Amperes)	57.0	72.0	40.0	52.0	52.0		74.0
Unit RLA (Amperes, MCC/1.44)	13.0	13.0	6.0	8.0	9.0	10.0	11.0
Net Weight (kg, including oil)	65.0		70.0	78.0	80.0		85.0
Oil Type	POE		POE		POE		POE

## Bill of Material

Standard BOM Content	BOM				
	300	301	302	303	304
Fan Motor	✓	✓	✓	✓	✓
CoreSense™	✓	✓	✓	✓	✓
Heat Exchanger	✓	✓	✓	✓	✓
Accumulator*			✓	✓	
Dual Pressure Switch	✓	✓	✓	✓	✓
Compressor With Rotalock Valve *		✓			
Compressor with Stub Tube*	✓		✓	✓	✓
Crank Case Heater	✓	✓	✓	✓	✓
Electrical Box	✓	✓	✓	✓	✓
Oil Separator*			✓		✓
Receiver with Valve	✓	✓	✓	✓	✓
Filter Drier - Flare Connection	✓	✓	✓	✓	✓
Moisture Indicator/ Sight Glass	✓	✓	✓	✓	✓
Solenoid Valve	✓	✓	✓	✓	✓
Canopy Enclosure*			✓		

\* Available as a customised solution.

## Nomenclature

I	Z	S	I	0	6	A	E	-	P	F	Z	-	3	0	0
I = Indoor Type CDU	Z = Scroll Compressor	S = Wide Operating Range	I = Liquid Injection	Compressor Nominal Capacity (k8tu/Hr) XX: IF < 100 XXX: IF ≥ 100	Chassis Type = A, B, C, D	Blank = Mineral Oil E = POE Oil			PFZ = 220-240V/ 1 Ph/ 50 Hz TFM = 380-420V/ 3 Ph/ 50 Hz						Bill of Material
Base Model											Electrical Code	BOM			



## E2 MEDIUM TEMPERATURE SERIES

Model	Capacity in Watts @ 6KTD			Air Flow		Fan Motors				Defrost Heater Watts	Weight (kg)	Connections				Dimensions (mm)			
	R404A	R22	R134A	l/s	Air Throw (m)	Fan Qty x Ømm	Amps	Watts	Power Supply			Inlet (mm)	Outlet (mm)	Ext Equaliser	Drain	Length	Width	Height	Mounting Centres 'A'
<b>E2 - MEDIUM TEMPERATURE SERIES (4.2mm FIN SPACING - 6FPI)</b>																			
E2-104-M/1.30	1040	940	960	364	8	1 x 300	0.30	68		14	12.7	15.88	6.35	650	415	430	360		
E2-142-M/1.30	1420	1340	1350	346	8	1 x 300	0.30	68		15	12.7	15.88	6.35	650	415	430	360		
E2-174-M/1.30	1740	1620	1700	316	7	1 x 300	0.30	68		20	12.7	15.88	6.35	650	415	430	360		
E2-236-M/2.30	2360	2240	2250	727	11	2 x 300	0.60	68		20	12.7	15.88	6.35	1080	415	435	760		
E2-261-M/2.30	2610	2370	2500	691	11	2 x 300	0.60	136		24	12.7	15.88	6.35	1080	415	435	760		
E2-355-M/2.30	3550	3400	3150	633	10	2 x 300	0.60	136		31	12.7	22.22	6.35	1080	415	435	760		
E2-384-M/2.30	3840	2650	3510	633	10	2X300	0.60	136		31	12.7	22.22	6.35	1080	415	435	760----		
E2-394-M/3.30	3940	3580	3690	1037	13	3 x 300	0.90	204		33	15.88	22.22	6.35	1515	465	440	1160		
E2-510-M/3.30	5110	4820	4860	999	13	3 x 300	0.90	204		37	15.88	22.22	6.35	1515	465	440	1160		
E2-528-M/3.30	5280	4910	5240	949	12	3 x 300	0.90	204		42	15.88	22.22	6.35	1515	465	440	1160		
E2-207-M/1.35	2070	1940	2050	721	13	1 x 350	0.58	132	240/1/50	20	12.7	15.88	6.35	880	465	505	560	NPT1	
E2-253-M/1.35	2530	2350	2350	679	13	1 x 350	0.58	132	NO ELEMENTS AS STANDARD	22	12.7	15.88	6.35	880	465	505	560		
E2-320-M/1.35	3200	2910	3180	624	13	1 x 350	0.58	132		28	12.7	19.05	6.35	880	465	505	560		
E2-492-M/2.35	4920	4470	4810	1359	15	2 x 350	1.16	264		36	15.88	22.22	6.35	1510	465	515	1160		
E2-625-M/2.35	6250	5880	6060	1312	15	2 x 350	1.16	264		42	15.88	22.22	6.35	1510	465	515	1160		
E2-739-M/2.35	7390	7040	6710	1248	14	2 x 350	1.16	264		48	15.88	28.60	6.35	1510	465	515	1160		
E2-765-M/3.35	7650	7110	7170	2038	17	3 x 350	1.74	396		52	15.88	28.60	6.35	2135	465	525	600 x 3		
E2-1018-M/3.35	10180	9760	9080	1966	17	3 x 350	1.74	396		60	15.88	28.58	6.35	2135	465	525	600 x 3		
E2-1125-M/3.35	11250	10740	10130	1872	16	3 x 350	1.74	396		68	15.88	35.00	6.35	2135	465	525	600 x 3		
E2-1353-M/4.35	13530	12940	12170	2599	19	4 x 350	2.32	528		77	15.88	35.00	6.35	2760	465	535	1200/1160		
E2-1487-M/4.35	14870	14150	13570	2496	18	4 x 350	2.32	528		86	15.88	35.00	6.35	2760	465	535	1200/1160		

- Capacities based on -4°C SST/ 6KTD for medium temperature models
- NOTE: Medium Temperature models are not fitted with defrost heater elements

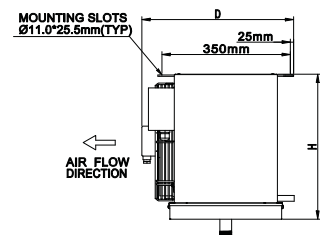
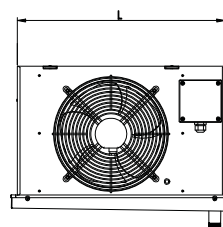



## E2 LOW TEMPERATURE SERIES

Model	Capacity in Watts @ 6KTD			Air Flow		Fan Motors				Defrost Heater	Weight (kg)	Connections				Dimensions (mm)			
	R404A	R22	R134A	l/s	Air Throw (m)	Fan Qty x Ømm	Amps	Watts	Power Supply	Watts		Inlet (mm)	Outlet (mm)	Ext Equaliser	Drain	Length	Width	Height	Mounting Centres 'A'
<b>E2 - LOW TEMPERATURE SERIES (6.0mm FIN SPACING - 4FPI)</b>																			
E2-073-L/1.30	730	670	720	351	8	1 x 300	0.30	68		440	14	12.7	15.88	6.35		650	415	430	360
E2-101-L/1.30	1010	980	890	336	8	1 x 300	0.30	68		440	15	12.7	15.88	6.35		650	415	430	360
E2-128-L/1.30	1280	1230	1040	367	7	1 x 300	0.30	68		660	20	12.7	15.88	6.35		650	415	430	360
E2-154-L/2.30	1540	1410	1590	702	11	2 x 300	0.60	136		880	20	12.7	15.88	6.35		1080	415	435	760
E2-220-L/2.30	2200	2130	1930	672	11	2 x 300	0.60	136		880	24	12.7	19.05	6.35		1080	415	435	760
E2-258-L/2.30	2580	2510	2270	646	10	2 x 300	0.60	136		1320	27	12.7	19.05	6.35		1080	414	435	760
E2-280-L/2.30	2800	2690	2560	623	10	2 x 300	0.60	136		1320	31	12.7	22.22	6.35		1080	415	435	760
E2-310-L/3.30	3100	2970	3020	1008	13	3 x 300	0.90	204		1600	33	15.88	22.22	6.35		1515	465	440	1160
E2-389-L/3.30	3890	3760	3370	969	12	3 x 300	0.90	204		2400	37	15.88	22.22	6.35		1515	465	440	1160
E2-436-L/3.30	4360	4220	3770	934	12	3 x 300	0.90	204		2400	42	15.88	28.60	6.35		1515	465	440	1160
E2-158-L/1.35	1580	1530	1420	685	13	1 x 350	0.58	132	240/150	1200	22	12.7	19.05	6.35	NPT1	880	465	440	1160
E2-188-L/1.35	1880	1810	1780	658	13	1 x 350	0.58	132		1200	22	12.7	19.05	6.35		880	465	505	560
E2-270-L/1.35	2700	2620	2310	613	13	1 x 350	0.58	132		1200	28	12.7	22.22	6.35		880	465	505	560
E2-406-L/2.35	4060	3910	3780	1317	15	2 x 350	1.16	264		1600	36	15.88	28.60	6.35		1510	465	515	1160
E2-482-L/2.35	4820	4660	4240	1269	14	2 x 350	1.16	264		2400	42	15.88	28.58	6.35		1510	465	515	1160
E2-548-L/2.35	5480	5300	4750	1226	14	2 x 350	1.16	264		2400	48	15.88	28.60	6.35		1510	465	515	1160
E2-629-L/3.35	6290	6090	5560	1976	17	3 x 350	1.74	396		2400	52	15.88	28.60	6.35		2135	465	525	600 x 3
E2-722-L/3.35	7230	6970	6570	1903	16	3 x 350	1.74	396		3600	60	15.88	34.92	6.35		2135	465	525	600 x 3
E2-795-L/3.35	7950	7630	7410	1838	16	3 x 350	1.74	396		3600	68	15.88	35.00	6.35		2135	465	525	600 x 3
E2-907-L/4.35	9070	8680	8920	2538	19	4 x 350	2.32	528		4800	77	15.88	35.00	6.35		2760	465	535	1200/1160
E2-1033-L/4.35	10330	9870	10060	2451	18	4 x 350	2.32	528		4800	86	22.22	41.28	6.35		2760	465	535	1200/1160

Suitable for E2 with no heater product

- Capacities based on -24°C SST/ 6KTD for low temperature models
- NOTE: Low Temperature evaporators are supplied with defrost elements fitted

PLEASE ASK FOR A FULL SPECIFICATION BOOKLET.

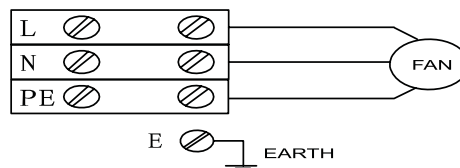

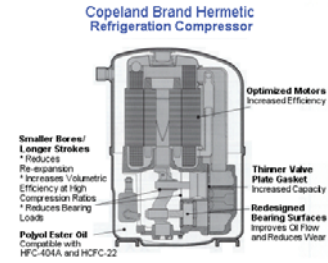

Introducing the Emerson Copland Hermetic Refrigeration compressor. A range of Fractional Horse Power compressors units that are manufactured at the Emerson plant in Atit, Western India. These are applied in diverse products like bottle cooler, freezers, industrial applications, display cabinets ice machines and low temperature applications in small retail. The Copeland® Brand FHP compressors come in the KCE, KCN & KCJ series and are compatible with R-22, R-134a, R-404A & R-290 refrigerants. Stareast through Refrigeration Agencies Australia engineered solutions can also produce FHP condensing unit as a customisation solution. This high efficiency series is engineered for lower compressor sound and reduced discharge pulse to decrease system sound and vibration. It also offers industry leading levels of reliability, especially at higher ambient temperatures, which is a critical factor in warmer ambient areas in Australia.

### Applications

Low Temperature	Medium Temperature	High Temperature
<ul style="list-style-type: none"> <li>• Deep Freezer</li> <li>• Refrigerator</li> <li>• Ice Cube machine</li> <li>• Walk-in Freezer</li> <li>• Laboratory Appliance</li> </ul>	<ul style="list-style-type: none"> <li>• Bottle Cooler</li> <li>• Visi Cooler</li> <li>• Display Cabinet</li> <li>• Pastry Cabinet</li> <li>• Softy Ice Cream</li> </ul>	<ul style="list-style-type: none"> <li>• Water Cooler</li> <li>• Oil Coolers / Panel Cooler</li> <li>• Water Chiller</li> <li>• Refrigerated Air Dryer</li> <li>• Walk in Cooler</li> <li>• Milk Cooler</li> </ul>



### Model Selection Guide\*

Deep Freezer		
Hard Top (Ltr)	Glass Top (Ltr)	Model
300	200	KCN372LA G
400	300	KCN396LA G
450	300	KCN411LA G
450	300	KCJ412LAG
500	400	KCN415LA G
800	-	KCJ423LAG
1100	-	KCJ430LAL
1800	-	KCJ450LAL



Cold Room (+4° C Room Temperature)			
Room Size (cf t)	R22	R134a	R404A
500	KCJ513HAE	KCM511C AL	KCJ484C AL
800	-	KCM511C AL	KCM511C AL
1200	-	KCM514C AL	KCM514C AL
1600	-	KCM519C AL	KCM514C AL
2000	-	KCM522C AL	KCM519C AL
2500	-	-	KCM522C AL



Water Cooler		
Capacity (Ltr/Hr)	R22	R134a
20	-	KCE419HA G
40	-	KCE444HA G/ KCJ444HA G
60	KCE461HAE	KCN463HA G/ KCJ467HA G
100	KCJ511HAE	KCJ498HA G
150	KCJ513HAE	KCM511C AL
200	-	KCM514C AL
300	-	KCM522C AL

\* These are preliminary guidelines. The actual compressor selection may differ from the guide lines. Please check the system details before selecting compressor model.



# R134a High Temperature

Model	Hz	HP	Displacement (CC/rev)	Performance at ASHRAE Rated Condition			Refrigeration Capacity (kW abs) #										Mechanical Specification										Electrical Specification				O/LP	
				Capacity (Btu/hr)	Power (W)	Current (A)	Exp. Temp./Cond. Temp. (°C)	-17.8	-15	-10	0	5	10	12.8	Oil Charge(cc)	Cooling Type (CFM)	Net Wt. (Kg)	I/P(A)	Voltage Range(V)	Motor Type	Fig No.	Start Capacitor (Mfd)	Run Capacitor (Mfd)	Relay								
																								W	A	Potential / P.T.C	Current					
<b>R134a, 1Phase</b>																																
KCE419HAG	50	1/6	5.79	1,588	465	1.40	43.3	184	219	271	322	457	558	677	800	310	Fan 350	10.20	12	180-260	RSIR	3	-	-	-	-	-	-	-	KARP3627	TAE19/HB	
KCE425HAG	60	1/5	7.58	1,861	545	1.50	43.3	215	257	317	384	476	608	792	936	310	Fan 350	10.20	11	207-253	CSIR	6	40/60	-	-	-	-	-	-	KARP4241	KAT0072/H3 or MRA12305-12101	
KCE432HAG	50	1/4	9.42	2,691	788	2.75	43.3	213	287	417	547	675	832	1,157	1,388	310	Fan 350	11.80	12.5	180-260	CSIR	6	40/60	-	-	-	-	-	-	KARP4241/ MTR4241	KAT0072/H3 or MRA12305-12101	
KCE444HAG	60	3/8	12.05	4,276	1,252	2.20	43.3	294	329	395	474	588	761	1,013	1,204	310	Fan 350	11.80	13	180-260	CSCR	4	40/60	10	-	-	-	-	-	KARP4241	KAT0072/H3	
KC1444HAG	50	3/8	12.58	3,702	1,084	2.80	43.3	282	340	444	532	703	939	1,266	1,588	890	Fan 350	20.20	17	180-260	CSIR	6	80/100	-	-	-	-	-	-	KARP4841/ MTR4841	KAT0159/B2	
KCM463HAG	50	1/2	15.33	5,252	1,538	2.70	43.3	-	-	-	-	-	-	-	-	380	Fan 350	11.50	14	180-260	CSCR	4	80/100	15	-	-	-	-	-	KAT0463/B2 / MRA12305-12102	KAT0463/B2 / MRA12305-12102	
KC467HAG	60	1/2	18.27	6,704	1,963	4.10	43.3	627	759	1,029	1,347	1,710	2,119	2,626	2,968	890	Fan 350	21.00	23	180-260	CSIR	6	80/100	-	-	-	-	-	-	-	KARP5641/ MTR5641	KAT0733/B2
KC498HAG	50	3/4+	25.91	8,203	2,402	5.90	43.3	1,115	1,185	1,355	1,627	2,049	2,567	3,182	3,596	890	Fan 350	21.50	32	198-242	CSIR	5	80/100	-	-	-	-	-	-	-	-	KAT0165 / B2
KCM511C AL	50	1 1/2	40.80	11,275	3,302	11.25	43.3	864	1,114	1,606	2,209	2,942	3,807	4,831	5,570	1,330	Fan 400	29.50	54	180-260	CSCR	4	80/100	36	-	-	-	-	-	-	Internal	
KCM514C AL	50	1 1/2	51.47	15,273	4,472	15.15	43.3	1,019	1,336	1,981	2,763	3,657	4,737	6,059	7,044	1,330	Fan 400	32.50	72	180-260	CSCR	4	150/200	45	-	-	-	-	-	-	Internal	
KCM519C AL	50	2 1/2	59.65	18,655	5,463	18.00	43.3	608	884	1,437	2,116	2,930	3,800	5,055	5,890	1,330	Fan 400	34.90	85	180-260	CSCR	4	130/156	40	-	-	-	-	-	-	Internal	
KCM522C AL	50	2 1/2	72.08	21,320	6,243	2.030	43.3	1,442	1,876	2,739	3,788	5,041	6,530	8,292	9,600	1,330	Fan 400	34.90	104	180-260	CSCR	4	189/227	60	-	-	-	-	-	-	Internal	
<b>R134a, 3 Phase</b>																																
KCM519C AL	50	2 1/2	59.65	18,655	5,463	18.00	43.3	1,172	1,571	2,358	3,299	4,409	5,771	7,450	8,541	1,330	Fan 400	31.00	41	342-460	3 Ph	-	-	-	-	-	-	-	-	-	-	Internal
KCM522C AL	50	2 1/2	72.08	21,320	6,243	2.030	43.3	939	1,310	2,058	2,985	4,090	5,406	6,994	8,148	1,330	Fan 400	37.00	45	342-460	3 Ph	-	-	-	-	-	-	-	-	-	-	Internal

## Permitted Evaporating Temperature Range in °C

Model	Refrigerant	High Temperature	Medium Temperature	Low Temperature
KC1, KC2, KC3, KC4, KC5	R134a	-17.8 to 12.8*	-17.8 to 12.9	-28.8 to -6.7**
KC6, KC7, KC8	R22	-6.7 to 12.8	N.A.	N.A.
KC9, KC10, KC11, KC12	R404A	N.A.	-17.8 to 10.0	-40.0 to -6.7

\* Except KCM463HAG / KC1498HAG: -6.7 °C to 12.8 °C

\*\* Except KC11: -37 °C to 6.7 °C

60 Hz compressor available for customised OEM solution

# EMERSON FRACTIONAL COMPRESSORS, REFRIGERATION

R134a R404A Medium Temperature

Model	Hz	HP	Dis- placement (CC/rev)	Performance at ASHRAE Rated Condition				Refrigeration Capacity (Watts) #										Mechanical Specification						Electrical Specification							
				Capacity		Power	Current	Evap. Temp./ Cond. Temp. (°C)	-178	-15	-10	0	5	10	12.8	Oil Charge(cc)	Cooling Type (CFM)	Net Wt (Kg)	LRA (A)	Voltage Range(V)	Motor Type	Fig No.	Start Capacitor (Mfd)	Run Capacitor (Mfd)	Relay						
				Btu/hr	W																				W	A	Potential / PT C	Current			
R134a, 1Phase																															
KCM13C AG	50	1/6	6.15	1,079	316	180	0.80	43.3	268	301	355	424	518	613	759	-	-	340	Fan 350	9.70	8	180-260	CSCR	4	40/60	6	PTC8EA19D7	-	-	KAT0411/H3	
KCM13C AG	60			1,240	363	205	0.80	43.3	235	243	289	355	446	538	656	-	-	340	Fan 350	9.70	8	207-253	CSCR	4	40/60	6	PTC8EA19D7	-	-	KAT0411/H3	
KCM16C AG	50	1/5	7.31	1,342	393	220	1.00	43.3	284	328	409	511	627	763	914	-	-	340	Fan 350	9.70	10	180-260	CSCR	4	40/60	6	PTC8EA19D7	-	-	KAT0413 /H3 or MRA12390-12101	
KCM16C AG	60			1,540	451	250	1.10	43.3	271	312	393	496	615	753	912	-	-	340	Fan 350	9.70	10	207-253	CSCR	4	40/60	6	PTC8EA19D7	-	-	KAT0413 /H3 or MRA12390-12101	
R404A, 1Phase																															
KCJ422C AL	50	1/4	8.00	1,800	527	400	2.40	43.3	405	472	603	754	922	1,108	1,385	-	-	890	Fan 350	20.00	16	180-260	CSIR	6	80/100	-	-	KARP741	-	-	KAT0465 /R2
KCJ498C AL	50	1/2	11.50	3,203	938	625	3.70	43.3	290	346	451	582	736	899	1,146	-	-	890	Fan 350	21.50	24	180-260	CSIR	6	80/100	-	-	KARP5641 / MTRP5641	-	-	T0732/B9
KCM461C AL	50	3/4	18.27	5,102	1,494	925	4.10	43.3	1,147	1,338	1,709	2,134	2,612	3,139	3,922	-	-	890	Fan 350	21.50	25	180-260	CSCR	4	80/100	25	HLR3800-413C-2	-	-	Internal	
KCJ494C AL	50	1	25.91	7,004	2,051	1,250	6.20	43.3	1,571	1,833	2,341	2,924	3,579	4,287	5,373	-	-	890	Fan 350	22.50	37	180-260	CSCR	4	80/100	25	HLR3800-413C-1	-	-	Internal	
KCM511C AL	50	1 1/2	40.80	8,975	2,628	1,385	6.30	43.3	-	2,022	2,666	3,475	4,387	5,373	6,647	-	-	1,330	Fan 400	29.80	54	180-260	CSCR	4	80/100	36	ACS5004	-	-	Internal	
KCM514C AL	50	1 1/4	51.47	11,947	3,498	1,840	8.70	43.3	-	2,666	3,675	4,927	6,389	8,079	10,064	10,971	-	-	1,330	Fan 400	32.50	72	180-260	CSCR	4	150/200	45	HLR3800-6H3C-1	-	-	Internal
KCM519C AL	50	2 1/2	59.65	16,025	4,692	2,560	12.30	43.3	-	3,780	4,998	6,480	8,204	10,203	12,511	13,588	-	-	1,330	Fan 400	34.90	85	180-260	CSCR	4	120/150	45	ACS5004 or 3ARR3C 3P-5 or RVA-3P6	-	-	Internal
KCM522C AL	50	2 1/4	72.08	18,205	5,331	2,600	12.00	43.3	-	4,600	5,900	7,490	9,393	11,770	14,562	15,792	-	-	1,330	Fan 400	34.90	104	180-260	CSCR	4	120/150	60	ACS5005 or 3ARR3C T2455 or RVA-3AG-6D	-	-	Internal
R404A, 3 Phase																															
KCM511C AL	50	1 1/2	40.80	9,484	2,777	1,380	2.40	43.3	-	1,904	3,219	4,217	5,347	6,438	7,471	7,684	-	-	1,330	Fan 400	29.50	20	342-462	3 Ph	-	-	-	-	-	-	Internal
KCM514C AL	50	1 1/4	51.47	13,051	3,822	1,865	3.50	43.3	-	2,824	4,685	6,087	7,524	9,028	10,943	11,903	-	-	1,330	Fan 400	30.00	28	342-462	3 Ph	-	-	-	-	-	-	Internal
KCM519C AL	50	2 1/2	59.65	15,776	4,620	2,225	4.70	43.3	-	3,692	4,922	6,368	8,107	10,113	12,432	13,449	-	-	1,330	Fan 400	31.00	41	342-460	3 Ph	-	-	-	-	-	-	Internal
KCM522C AL	50	2 1/4	72.08	18,275	5,352	2,600	5.20	43.3	-	4,600	5,900	7,490	9,393	11,770	14,561	15,792	-	-	1,330	Fan 400	32.70	45	342-460	3 Ph	-	-	-	-	-	-	Internal

Notes

1. Electrical rating is 240V, 50 Hz and 230V, 60 Hz for single phase models and, 415 V, 50 Hz for three phase models. Customisable items.
2. Operating voltage range signifies the range of voltage for which the compressor can start and run up to 43°C ambient.
3. Cooling capacity and power consumption are nominal values at specified rating conditions and subject to ±5% variation.
4. Direct air flow on glass terminal cover should be avoided.
5. Compressors with CSIR circuit and three phase models may be used with thermostatic expansion valve.
6. Compressors with RSIR Circuit must use capillary tube only. Fan motor required if application changes.
7. All compressors use two pole motors.
8. Compressors for specific applications are rated for IS-10617 P part and Part III-1983.
9. All run capacitor should have a rating of 440 VAC and start capacitor 275 VAC surge, unless otherwise specified by Emerson Climate Technologies (India) Limit

**R134a** **R404A** Low Temperature

Model	Hz	HP	Displacement (CC/rev)	Performance at ASRE/T Rated Condition			Refrigeration Capacity (Watts) #										Mechanical Specification						Electrical Specification						
				Capacity	Power	Current	Evap. Temp. / Cond. Temp. (°C)	-37.2	-35	-30	-25	-20	-15	-10	-6.7	Oil Charge(cc)	Cooling Type (CFM)	Net Wt. (Kg.)	LRA (A)	Voltage Range(V)	Motor Type	Fig No.	Start Capacitor (Mfd)	Run Capacitor (Mfd)	Relay Potential/PT C	Current	OLP		
<b>R134a, 1 Phase</b>																													
KCN372LAG	50	1/5	731	601	176	159	1.34	43.3	80	94	130	181	246	321	404	462	340	Oil / Fan 260	10.20	10	180-260	CSR	6	40/60	-	-	KARP-3141/ MTRP-3141/ KARP3227	TAE15/H3	
KCN396LAG	50	1/4	900	803	235	205	1.85	43.3	76	86	115	162	223	294	377	438	340	Oil / Fan 260	10.20	10	180-260	CSR	6	40/60	-	-	KARP 4141/ MTRP 4141	TAE5MH3	
KCN411LAG	50	1/3	1110	963	282	245	2.10	43.3	-	107	157	215	276	343	418	471	340	Oil / Fan 260	11.50	10	180-260	CSR	6	40/60	-	-	KARP241/ MTRP241	MFA12309-12101	
KC412LAG	50	1/3	1635	1,028	301	280	2.75	43.3	-	-	358	500	683	907	1068	890	890	Fan 350	21.00	24	180-260	CSR	6	80/100	-	-	MTRP 4841/ KARP4841	KAT0159/B2	
KCN415LAG	50	3/8	1533	1,267	371	325	1.80	43.3	-	150	259	373	509	677	867	1,000	380	Fan 350	11.50	14	180-260	CSCR	4	80/100	10	-	LT85002 OR HL83800-413C-2	KAT007/H3 or MRA-12309-12101	
KC423LAG	50	1/2	3261	1,933	566	485	3.00	43.3	-	112	210	328	466	625	805	932	890	Fan 350	22.50	30	198-264	CSCR	4	150/200	10	-	LT85003	T0132/B2 or KAT0732/B2	
<b>R404A, 1 Phase</b>																													
KCN414LAG	50	1/3	731	1,325	388	325	2.30	43.3	166	198	263	354	458	578	727	838	340	Fan 350	10.20	16	180-260	CSR	6	60/80	-	-	KARP- 4241	KAT007/H3 or MRA3309-12101	
KCN418LAG	50	1/2	900	1,455	426	385	2.00	43.3	137	159	222	307	399	506	640	738	380	Fan 350	11.50	14	180-260	CSCR	4	80/100	10	-	LT85002 or HL83800-413C-2	MRA12309-12102 or T0022/B2	
KCN422LAG	50	1/2	1110	1,834	537	455	2.20	43.3	205	257	354	470	607	759	934	1,065	380	Fan 350	11.50	17	180-260	CSCR	4	80/100	15	-	LT85003 or HL83800-413C-3	KAT0164/B2 OR T0164/K9	
KCN430LAG	50	1/5	1533	2,575	754	580	4.40	43.3	256	321	443	588	759	949	1,168	1,331	380	Fan 350	11.50	18	180-260	CSCR	4	80/100	15	-	LT85003 or HL83800-413C-3	KAT0733/B2	
KC430LAG	50	3/4	1635	2,435	713	580	3.20	43.3	225	255	348	486	635	802	1,015	1,182	420	Fan 350	22.50	30	180-260	CSCR	4	150/200	10	-	AC85003 or HL83800-413C-3	Internal	
KC450LAG	50	1 1/4	3264	4,118	1,206	1,000	5.50	43.3	364	454	626	831	1,074	1,342	1,652	1,883	890	Fan 350	25.00	50	180-260	CSCR	4	150/200	25	-	AC85005	Internal	
KCM475LAG	50	1 1/2	5147	5,703	1,670	1,250	6.80	43.3	416	591	934	1325	1771	2,235	2,698	3,003	1,300	Fan 350	32.50	72	198-264	CSCR	4	150/200	25	-	AC85004	Internal	
<b>R404A, 3 Phase</b>																													
KCM515LAG	50	3 1/4	8968	12,506	3,662	2,460	5.10	43.3	1,933	2,344	3,238	4,057	5,044	6,242	7,650	8,666	1,300	Fan 350	32.70	45	342-460	3 Ph	-	-	-	-	-	-	Internal

**ASRE/T Rating Conditions**

Ambient Temperature	Evaporating Temperature	Condensing Temperature	Sub-Cooled Liquid Temp	Suction Pressure		Suction Gas Temperature		Suction Pressure		Discharge Pressure	
				R134a	R22	R134a	R22	R134a	R22	R404A	R404A
High Temperature	°C	°C	°C	psig	psig	°C	°C	psig	psig	psig	psig
35	7.2	54.4	46.1	35	40	77	93.7	196	300	354	354
Medium Temperature	°C	°C	°C	psig	psig	°C	°C	psig	psig	psig	psig
35	-6.7	54.4	46.1	35	18	---	55.6	196	---	354	354
Low Temperature	°C	°C	°C	psig	psig	°C	°C	psig	psig	psig	psig
32	-23.3	54.4	32	32	1.9	---	24.6	196	---	354	354

**EMERSON FRACTIONAL COMPRESSORS, REFRIGERATION**



**TI Series**  
**Thermo®Expansion Valves**

**Alco Controls**

**Featured Items**

**Selection table: Valve bodies without orifice and nuts in single packaging**

Add letter M to end of PCN for CUSTOMISED OEM packing of 20 valves in one carton (example: 20 x 802465M)

Refrigerant	Outlet/Equalizer Connection Type	External Equalizer		Internal Equalizer		Charge	MOP function	
		Type	Part No.	Type	Part No.			
R 404A/ R 507	Braze stainless steel fittings*	TILE-SW (12mm)	EM802465	-		Liquid	No	
		TILE-SW (1/2")	EM802466	-		Liquid	No	
	Braze copper fittings**	TISE-SW (12mm)	EM802462	TIS-SW (12mm)	EM802461	Liquid	No	
		TISE-SW (1/2")	EM802464	TIS-SW (1/2")	EM802463	Liquid	No	
		TISE-SAD10 (1/2")	EM802479	TIS-SAD10 (1/2")	EM802478	Adsorption	Yes***	
		TISE-SW75 (12mm)	EM802471			Vapour	Yes	
		TISE-SW75 (1/2")	EM802472			Vapour	Yes	
		TISE-SAD-20 (12mm)	EM802474			Adsorption	Yes***	
	Flare fittings	TISE-SAD-20 (1/2")	EM802475			Adsorption	Yes***	
		TIE-SW	EM802460	TI-SW	EM802459	Liquid	No	
		TIE-SAD10	EM802477	TI-SAD10	EM802476	Adsorption	Yes***	
		TIE-SW75	EM802470	TI-SW75	EM802469	Vapour	Yes	
	R 134a	Braze stainless steel fittings*	TIE-SAD-20	EM802473			Adsorption	Yes***
			TILE-MW (12mm)	EM802451			Liquid	No
Braze copper fittings**		TILE-MW (1/2")	EM802452			Liquid	No	
		TISE-MW (12 mm)	EM802448	TIS-MW (12 mm)	EM802447	Liquid	No	
		TISE-MW (1/2")	EM802450	TIS-MW (1/2")	EM802449	Liquid	No	
		TISE-MW55 (12mm)	EM802457			Vapour	Yes	
Flare fittings	TISE-MW55 (1/2")	EM802458			Vapour	Yes		
	TIE-MW	EM802446	TI-MW	EM802445	Liquid	No		
R 407C	Braze stainless steel fittings*	TIE-MW55	EM02456	TI-MW55	EM802455	Vapour	Yes	
		TILE-NW (12mm)	EM802486			Liquid	No	
	Braze copper fittings**	TILE-NW (1/2")	EM802485			Liquid	No	
		TISE-NW (12mm)	EM802438	TIS-NW (12mm)	EM802437	Liquid	No	
	Flare fittings	TISE-NW (1/2")	EM802440	TIS-NW (1/2")	EM802439	Liquid	No	
		TIE-NW	EM802436	TI-NW	EM802435	Liquid	No	
R 22	Braze stainless steel fittings*	TIE-NW	EM802436	TI-NW	EM802435	Liquid	No	
		TILE-HW (12mm)	EM802426			Liquid	No	
	Braze copper fittings**	TILE-HW (1/2")	EM802427			Liquid	No	
		TISE-HW (12mm)	EM802423	TIS-HW (12mm)	EM802422	Liquid	No	
		TISE-HW (1/2")	EM802425	TIS-HW (1/2")	EM802424	Liquid	No	
		TISE-HW100 (12mm)	EM802431			Vapour	Yes	
	Flare fittings	TISE-HW100 (1/2")	EM802432			Vapour	Yes	
		TIE-HW	EM802421	TI-HW	EM802420	Liquid	No	
	TIE-HAD10	EM802430			Adsorption	Yes***		

\*) TILE Braze without wet CLOTH

\*\*) TISE Braze with wet CLOTH OR GEL

\*\*\*) MORE INFORMATION PLEASE ASK

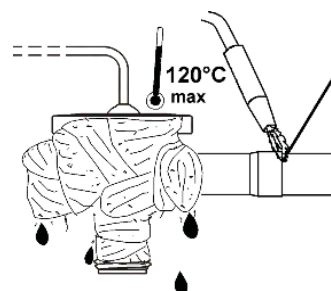
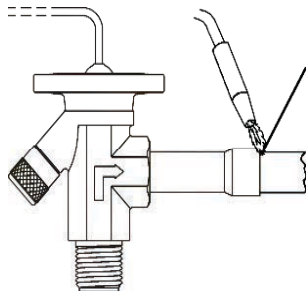



# Thermo™ -Expansion Valves Series TI

New valve design, exchangeable orifices

## Features

- Laser-welded diaphragm with large diameter for high reliability and maximum lifetime
- Constant superheat across wide application ranges Easy and precise superheat setting by modified threads
- TILE with stainless steel fittings allow brazing without wet cloths
- With capacities between 0.4 kW and 14.2 kW (R404A) ideally suited for service work
- Internal or external equaliser
- Brazing and flare connections available
- Capillary tube length 1.5 m
- PS: 45 bar. TS: -45 ... +75°C
- No CE marking according art. 3.3 PED 97/23 EC

## Type Code

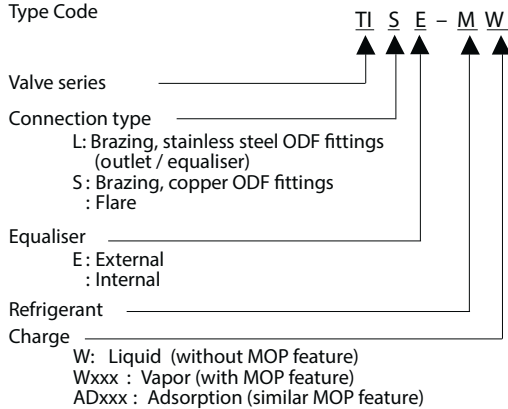

## Featured Items



TILE



TIE

## Orifice Assembly with strainer for inlet connection

Type	Nominal Capacity* (kW)							
	TIO-00X	TIO-000	TIO-001	TIO-002	TIO-003	TIO-004	TIO-005	TIO-006
Part No	EM800532	EM800533	EM800534	EM800535	EM800536	EM800537	EM800538	EM800539
R134a	0.3	0.8	1.9	3.1	5.0	8.3	10.1	11.7
R22	0.5	1.3	3.2	5.3	8.5	13.9	16.9	19.5
R404A	0.4	1.0	2.3	3.9	6.2	10.1	12.3	14.2
R407C	0.5	1.4	3.5	5.7	9.2	15.0	18.3	21.1
R410A	0.6	1.5	3.7	6.2	9.9	16.2	19.7	22.8
R507	0.4	1.0	2.3	3.9	6.2	10.1	12.3	14.2
R407F	0.6	1.5	3.6	5.9	9.5	15.5	18.9	21.8

## Brazing Adapter for TILE and TIS(E)

Type	Part No.	Connection, ODF	
		mm	inch
TIA-M06	EM802500	6.0	-
TIA-M10	EM802501	10.0	-
TIA-014	EM802502	-	¼"
TIA-038	EM802503	-	¾"
Gasket Set	EM803780	100 pieces	



\*Nominal capacity is based on the following conditions:

Refrigerant	Evaporating temperature	Condensing temperature	Sub-cooling
R407C, R407F	+4°C dew point	+38°C bubble p. +43°C dew point	1K
R22, R134a, R404A, R410A, R507	+4°C	+38°C	1K

Valve selection for other operating conditions are available on request for Thermo-Expansion Valves Series TI, TX3, TX6, T and L". Please speak to the Stareast trade qualified staff or our engineers for more information.

# EK Liquid Line Filter Drier



## System Protectors

The EK Liquid Line Filter Drier is a premium compacted bead Filter Drier with a fine 20 micron fine outlet pad for maximum filtration. The EK is a premium universal replacement liquid line Filter Drier for CFC, HCFC and HFC refrigerants including R-12, R-134a, R-22, R-404A, R-407C, R-410A, R-500, R-502, and R-507.



### Features

- Filtration first for more effective use of surface area of desiccant
- High moisture and acid removal capacity
- Solid copper connections
- Corrosion resistant epoxy powder paint finish
- Copeland® brand products approved for POE Oils
- Shock resistant steel shell construction

### Specifications

- Desiccant blend - optimized for high water capacity and acid capacity
- Filtration: 20 microns
- Maximum working pressure: 680 psig
- UL/CUL File number: SA 3124

Nomenclature example: EK-083S

EK	08	3	S
Drier Series	Unit Size (in cu. in.)	Connection Size (in 1/8")	S = ODF connections (omit for SAE)

### Dimensional Data

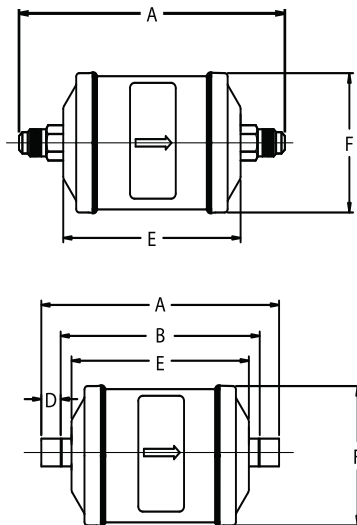

- Ask for a data Sheet for Filtration capacities and sizes available on request from our Stareast Staff Member.

### Ordering Information

PCN	Description	Dimensions (in)						Weight (lbs)		
		A	B	D	E	F				
EM060009	EK 032	4.38	-	-	-	-	2.56	1.63	0.50	
EM060012	EK 032S	3.88	3.13	0.38	-	-				
EM060011	EK 032FM	3.50	-	-	-	-				
EM060010	EK 032MF	3.50	-	-	-	-				
EM060013	EK 033	4.69	-	-	-	-	3.00	-	-	
EM060014	EK 033S	4.06	3.19	0.44	-	-				
EM047601	EK 052	4.81	-	-	-	-	3.00	-	-	
EM057013	EK 052MF	4.50	-	-	-	-				
EM063978	EK 0525S	3.57	0.32	2.64	3.02	-	3.00	-	0.88	
EM047602	EK 052S	4.44	3.69	0.38	-	-				
EM047603	EK 053	5.13	-	-	-	-				
EM047604	EK 053S	4.50	3.63	0.44	-	-				
EM047605	EK 082	5.63	-	-	-	-	3.81	2.63	-	1.25
EM047606	EK 082S	5.25	4.50	0.38	-	-				
EM049551	EK 0825S	5.38	4.38	0.50	-	-	4.75	-	-	1.25
EM056906	EK 083MF	5.94	-	-	-	-				
EM047607	EK 083	5.31	4.44	0.44	-	-	4.75	-	-	1.25
EM047608	EK 083S	5.31	4.44	0.44	-	-				
EM047609	EK 084	6.19	-	-	-	-	4.75	-	-	1.25
EM047610	EK 084S	5.38	4.38	0.50	-	-				
EM047611	EK162	6.56	-	-	-	-	7.50	3.06	-	3.75
EM047612	EK 162S	6.19	5.44	0.38	-	-				
EM056045	EK 1625S	5.94	5.31	0.31	-	-	7.50	3.06	-	3.75
EM047613	EK 163	6.88	-	-	-	-				
EM047614	EK 163S	6.25	5.44	0.44	-	-	7.50	3.06	-	3.75
EM047615	EK 164	7.06	-	-	-	-				
EM047616	EK 164S	6.31	5.31	0.50	-	-	7.50	3.06	-	3.75
EM047617	EK 165	7.50	-	-	-	-				
EM047618	EK 165S	6.56	5.31	0.63	-	-	7.50	3.06	-	3.75
EM047619	EK 167S	7.50	5.63	0.75	-	-				
EM048210	EK 303	9.63	-	-	-	-	7.50	3.06	-	3.75
EM048211	EK 303S	9.00	8.13	0.44	-	-				
EM048212	EK 304	9.88	-	-	-	-	7.50	3.06	-	3.75
EM048213	EK 304S	9.13	8.13	0.50	-	-				
EM048214	EK 305	10.31	-	-	-	-	7.50	3.06	-	3.75
EM048215	EK 305S	9.31	8.06	0.63	-	-				
EM048216	EK 306S	9.69	8.44	-	-	-	7.50	3.06	-	3.75
EM048217	EK 307S	9.88	8.38	0.75	-	-				
EM048218	EK 309S	10.25	8.44	0.94	-	-	7.50	3.06	-	3.75
EM048219	EK 413	9.75	-	-	-	-				
EM048220	EK 414	10.00	-	-	-	-	7.63	3.69	-	4.75
EM048221	EK 414S	9.25	8.25	0.50	-	-				
EM048222	EK 415	10.44	-	-	-	-	7.63	3.69	-	4.75
EM048223	EK 415S	9.44	8.19	0.63	-	-				
EM048224	EK 417S	10.00	-	-	-	-	7.63	3.69	-	4.75
EM048225	EK 419S	10.94	8.50	0.75	-	-				
EM048228	EK 757S	15.44	13.94	-	-	-	13.06	-	-	7.50
EM048229	EK 759S	15.75	13.88	0.94	-	-				

<sup>1</sup>Does not include weld bead

## Pressure Controls Series PS1 / PS2

### Features

- Adjustable pressure range
- Automatic and manual reset versions
- Flare and solder connections
- Chatter resistant contacts
- High operational current, locked rotor max. 144 Amps (LRA)
- Standard SPDT with same operational current rating for both contacts
- Dual pressostat with two separate SPDT for high and low pressure side
- Including sealable blocking plate and mounting screws

### Options

- Convertible reset to reduce stock
- Further pressure connections
- Factory set to customised specification



PS2

PS1

### Standards

- per Low Voltage Directive
- per PED Directive 97/23 EG. TÜV appr. versions only
- Manufactured and tested to standards
- US LISTED Underwriter Laboratories (File Nr. E85974)
- German Lloyd for use on ships, when equipped with marine-type cable gland

### Technical Data PS1 / PS2

Type of Contacts	1 SPDT for PS1 2 separate SPDT for PS2
Inductive Amp. (AC15) Inductive Amp. (DC13)	10 A / 230V AC 0.1 A / 230V DC
Motor Rating, Full Load Amp. Motor Rating, Locked Rotor Amp.	24 A / 120/240V AC 144 A / 120/240V AC

Protection acc. EN 60529 / IEC 529	IP 44
Ambient Temperature Range Max. Temperature at Pressure Connection	-50°C .. +70°C +70°C
Vibration Resistance (10 to 1000 Hz)	4 g
Cable Entry	Grommet PG 16
Locking Device	Blocking Plate
Mounting Screws	M4 / UNC 8-32

### Single Pressure Controls PS1

Type	Part No.	Adjustment Range		Lowest Setpoint bar	Factory Setting bar	Leakage Test Pressure bar	Pressure Connection
		Upper Setpoint bar	Differential bar				
Low Pressure Controls							
PS1-A3A	EM4370700	0.5 ... 7	0.5 ... 5	0.9	3.5 / 4.5	24	1/4 capillary & nut
High Pressure Controls							
PS1-A5A	EM4350500	6 ... 31	2 ... 15	3	16 / 20	35	1/4 capillary & nut

### Dual Pressure Controls Series PS2



PS2

Type	Part No.	Adjustment Range				Factory Setting		Leakage Test Pressure		Pressure Connection
		Upper Setpoint		Differential				left bar	right bar	
		left bar	right bar	left bar	right bar	left bar	right bar			

Combined Low and High Pressure Controls. High Side Convertible From Automatic to Manual Reset										
PS2-M7A	EM4361300	-0.5 .. 7	6 ... 31	0.5a ... 5	-	3,5 / 4,5	21	24	35	1/4 FIT CAPILLARY

## SOFT DRAWN COPPER TUBE



Strictly conforms and complies with all Australian standards AS/NZS 1573:1995

RF300	1/4"x0.81x30M* 21G
RF301	5/16"x0.81x30M 21G
RF302	3/8"x0.81x18M* 21G
RF303B	5/8"x1.02x18M* 19G
RF304	1/2"x0.81x18M* 21G
RF305	3/4"x0.91x18M 20G
RF305B	3/4"x1.14x18M* 18.5G
RF306	3/16"x0.71x30M, 22G
RF311	7/8"x1.40x18M* 17G

\* Suitable for R410A refrigerant

## HARD DRAWN COPPER TUBE



RF344A	1/4"x0.81MMX6M 21G*
RF344	3/8"x0.81MMX6M 21G*
RF345	1/2"x0.81MMX6M 21G*
RF346	5/8"x0.81MMX6M 21G
RF346A	5/8"x1.02MMX6M* 19G
RF347	3/4"x0.91MMX6M 20G
RF347A	3/4"x1.14MMX6M* 18.5G
RF348	7/8"x0.91MMX6M 20G
RF348A	7/8"x1.40MMX6M* 17G
RF349	1"x0.91MMX6M 20G
RF349A	1"x1.63MMX6M* 16G
RF350	1 1/8"x0.91MMX6M 20G
RF350A	1 1/8"x1.83MMX6M* 15G
RF350B	1 3/8"x2.03MMX6M* 14G
RF350C	1 5/8"x2.41MMX6M* 12.5G
RF350D	1 5/8"x0.91MMX6M 20G
RF350E	2 1/8"x1.22MMX6M 18G
RF350F	2 5/8"x1.22MMX6M 18G

\* Suitable for R410A refrigerant, ask for larger sizes.

## COPPER SADDLES



RF480	1/4"	RF485	7/8"
RF481	3/8"	RF486	1"
RF482	1/2"	RF487	1 1/8"
RF483	5/8"	RF488	1 1/2"
RF484	3/4"		

## PAIR/TWIN COIL



R410A Rated

RF380	1/4-3/8" 20M 6X9
RF381	1/4-1/2" 20M 6X12.7
RF382	1/4-5/8" 20M 6X15
RF383	3/8-5/8" 20M 9X15
RF384	3/8-3/4" 20M 9X20
RF385	1/2-3/4" 20M 12.7X19
RF385A	3/8-1/2" 20M 9X12.7

Fire Rated/R410A

RF380FR	1/4-3/8" 20M 6X9
RF381FR	1/4-1/2" 20M 6X12.7
RF382FR	1/4-5/8" 20M 6X15
RF383FR	3/8-5/8" 20M 9X15

## COLOURBOND TRUNKING

Surfmist	Evening Haze	Shale Grey	Classic Cream	Dune
Windspray	Pale Eucalypt	Sandbank	Paperbark	Bushland
Ironstone	Wilderness	Jasper	Headland	Woodland Grey
Deep Ocean	Cottage Green	Loft	Manor Red	Monument

RF387	CLASSIC CREAM (CREAM)
RF387A	SURFMIST (WHITE)
RF387AO	OFF WHITE
RF387B	JASPER (LIGHT BROWN)
RF387C	IRON BARK (DARK BROWN)
RF387D	NIGHT SKY (BLACK)
RF387E	(MED GREEN) COTTAGE GREEN
RF387F	DUNE (OFF GREY)
RF387G	MANOR RED (MED RED)
RF387H	PALE EUCALYPT (PALE GREEN)
RF387I	GALVANISED

2.4m length  
Other colours available upon request.

**DID YOU KNOW WE PRICE BASED ON YOUR PROJECTS BASED ON CURRENT MARKET PRICE ON COPPER AND TRUKING. GREAT LME PRICING JUST ASK ONE OF OUR STAFF.**

## WALL/ROOF BRACKETS, AIR CON MOUNTS & ACCESSORIES

All Stareast powder coated brackets are made of galvanised steel sheet with white powder-coated surface and supplied with screws & anti-vibration accessories. The Stainless Steel Brackets are rated from high quality materials and workmanship.

### HC SERIES



HC-500	AIR-COND S035C WALL BRACKET 200kg 500mm POWDER COATED
HC-550	AIR-COND S036C WALL BRACKET 200kg 550mm POWDER COATED
HC-A021C	AIR-COND Stainless/Steel WALL BRACKET 3 pcs 180kg
HC-A022C	AIR-COND Stainless/Steel WALL BRACKET 3PC 250kg max
HC-A023C	AIR-COND Stainless /Steel WALL BRACKET 250K 3PC
HC-P050C	AIR-COND Stainless /Steel WALL BRACKET 250kg

Adjustable installation distance with level system. Please Ask for a data sheet if unsure of selection.

### ROOF SERIES



HC500-ROOF	AIR-COND P050C ROOF BRACKET 200kg 500mm
HC-P049C	AIR-COND S/S ROOF BRACKET 200KG STANLESS

### HEAVY DUTY BRACKET GALVANISED



SP-900A	AIR CON WALL BRACKET GALV CHANNEL 470MM
SP-900	AIR CON WALL BRACKET GALV CHANNEL 635MM

### SMARTCO BRACKETS

SHBWB250	AIR-COND WALL BRACKET 250kg 2.00MM P/COATED
SHBWB180	AIR-COND WALL BRACKET 180KG 180KG P/COATED



SP SERIES



4 Fixing Screws.

SP-400	110KG (1.5HP) LOAD A400 X B390
SP-450	120KG+ (2.5HP) LOAD A450 X B390
SP-550	170KG (3.5HP) LOAD A550 X B490

AIR CON MOUNTS & ACCESSORIES



RF400	RUBBER FEET FOR A/C SHORT
RF400SE	RUBBER FEET FOR A/C LONG



RF400A	4 PACK ROUND ADJUSTABLE RUBBER FEET
RF400B	4 PACK ROUND ADJUSTABLE RUBBER FEET



RFAUS1	ADJUSTABLE UNIT SUPPORT 110(L) x 110(W) x 110-140(H)mm
--------	--

CONDENSER UNIT GUARDS



RFB6192	SMALL 700x1000x450
RFB6191	MEDIUM 1100x1100x600
RFB6190	LARGE 1400x1100x600

This range of easy to install, aesthetically pleasing guards is made of painted aluminium structure to deter vandals and prevent damage to valuable equipment.



50mm mesh standard, Colourbond black finish, 3 sizes available in flat-pak.

RFVFPSC5	600 (H) X 1000 (W) X 600 (D)
RFVFPSC1	900 (H) X 1200 (W) X 600 (D)
RFVFPSC3	1300 (H) X 1200 (W) X 600 (D)

PIPE SUPPORTS, CHANNEL & INSULCLIPS



Corrosion resistant and can be used both internally and externally.

RFB6268	1/4"	RFB6264	1 1/8"
RFB6274	3/8"	RFB6265	1 3/8"
RFB6267	1/2"	RFB6266	1 5/8"
RFB6276	5/8"	RFB6269	2 1/8"
RFB6273	3/4"	RFB6270	2 5/8"
RFB6277	7/8"		

QUICK POSITIONING CLIPS



Make from UV resistant plastic and fitted into standard strut channels by a single twist.

RFB6445	1/4"	RFB6449	7/8"
RFB6447	3/8"	RFB6442	1 1/8"
RFB6444	1/2"	RFB6443	1 3/8"
RFB6448	5/8"	RFB6538	1 5/8"
RFB6446	3/4"		

SLOTTED CHANNEL



CS-001	41MMX41MMX3M
CS-002	41MMX21MMX3M
CS-003	41MMX41MMX1M
CS-004	41MMX21MMX1M

THREADED ROD



THR-001	M10 3M ZP
---------	-----------

ACCESSORIES



RF003	M10 x 25mm Zinc plated bolt. Sold individually.
RF003A	Channel nut to suit high profile channel, Zinc plated, Suits M10 thread.
RF003B	Channel nut to suit low profile channel, Zinc plated, Suits M10 thread.
NEED MORE	INFORMATION ASK THE STAFF-FOR A DATA SHEET



RFPLD10M	M10 MASONRY DROP IN ANCHOR 4PK
----------	--------------------------------

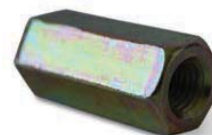

RFRC10Z	ROD COUPLER M10 ZP 4PK
---------	------------------------



RF442	WAFFLE PAD 450MM X 450MM
-------	--------------------------



RF835	POLYSLAB WITH PLASTIC SURFACE
-------	-------------------------------

INSULATION PIPE



Strictly conforms and complies with Australian standards AS4859, BCA code of Australia. Specified Building & equipment Insulation

**13mm Fire Rated (FR) 2M LENGTH GREY**

Inside Diameter		Product Code	Quantity per carton	
mm	Inches		lengths	metres
6	1/4	RF372BFR	50	100
10	3/8	RF373BFR	50	100
12	1/2	RF374BFR	40	80
15	5/8	RF375BFR	36	72
20	3/4	RF376BFR	32	64
22	7/8	RF377BFR	28	56
25	1	RF378BFR	23	46
28	1 1/8	RF379BFR	43	86
32	1 1/4	RF9B130321	35	70
35	1 3/8	RF9B130351	33	66
40	1 1/2	RF9B130401	30	60
42	1 5/8	RF9B130421	24	48
50	2	RF9B130501	20	40
54	2 1/8	RF9B130541	20	40
60	2 3/8	RF9B130601	16	32
67	2 5/8	RF9B130671	15	30
76	3	RF9B130768	14	28
80	3 1/8	RF9B130808	12	24
89	3 1/2	RF9B130898	12	24
101	3 7/8	RF9B131011	8	16
114	4 1/2	RF9B131141	6	12

**19mm Fire Rated (FR) 2M LENGTH GREY**

Inside Diameter		Product Code	Quantity per carton	
mm	Inches		lengths	metres
6	1/4	RF372FR	54	108
10	3/8	RF373FR	50	100
12	1/2	RF374FR	42	84
15	5/8	RF375FR	36	72
20	3/4	RF376FR	36	72
22	7/8	RF377FR	30	60
25	1	RF378FR	30	60
28	1 1/8	RF379FR	25	50
32	1 1/4	RF9B190321	20	40
35	1 3/8	RF9B190351	20	40
40	1 1/2	RF9B190401	18	36
42	1 5/8	RF9B190421	16	32
50	2	RF9B190501	16	32
54	2 1/8	RF9B190541	12	24
60	2 3/8	RF9B190601	9	18
67	2 5/8	RF9B190671	9	18
76	3	RF9B190761	8	16
80	3 1/8	RF9B190801	7	14
89	3 1/2	RF9B190891	7	14
101	3 7/8	RF9B191011	6	12
114	4 1/2	RF9B191141	6	12

**25 mm Fire Rated (FR) 2M LENGTH GREY**

Inside Diameter		Product Code	Quantity per carton	
mm	Inches		lengths	metres
10	3/8	RF373GFR	30	60
12	1/2	RF374GFR	30	60
15	5/8	RF375GFR	25	50
20	3/4	RF376GFR	25	50
22	7/8	RF377GFR	20	40
25	1	RF378GFR	20	40
28	1 1/8	RF379GFR	16	32
32	1 1/4	RF379IFR25	16	32
35	1 3/8	RF9B250351	16	32
40	1 1/2	RF9B250401	15	30
42	1 5/8	RF9B250421	12	24
50	2	RF9B250501	9	18
54	2 1/8	RF9B250541	9	18
60	2 3/8	RF9B250601	9	18
67	2 5/8	RF9B250671	8	16
76	3	RF9B250761	5	10
80	3 1/8	RF9B250801	5	10
89	3 1/2	RF9B250891	4	8
101	3 7/8	RF9B251011	4	8
114	4 1/2	RF9B251141	4	8

**FR SELF SEAL 13MM 2 METER LENGTH GREY**

Inside Diameter		Product Code	Quantity per carton	
mm	Inches		lengths	metres
10	3/8	RF9SFR1310	44	88
12	1/2	RF9SFR1312	35	70
15	5/8	RF9SFR1315	32	64
20	3/4	RF9SFR1320	30	60
22	7/8	RF9SFR1322	22	44
25	1	RF9SFR1325	20	40
28	1 1/8	RF9SFR1328	36	72
32	1 1/4	RF9SFR1332	30	60
35	1 3/8	RF9SFR1335	30	60
42	1 5/8	RF9SFR1342	24	48

**FR ARMAFLEX SHEET 1M X 1.5M SELF-ADHESIVE GREY**

Inside Diameter		Product Code	Quantity per carton	
mm	Inches		SHEETS	sq. meters
6	1/4	RF9U060001	30	45
9	3/8	RF9U090001	20	30
13	1/2	RF9U130001	15	22.5
19	3/4	RF9U190001	10	15
25	1	RF9U250001	8	12

**DONT SEE THE INSULATION YOU NEED, ASK ONE OF OUR FRIENDLY STAFF AND WE WILL BE ABLE TO HELP YOU WITH YOUR PROJECT. ALL SIZES AVAILABLE.**

**PVC FITTINGS CONDENSATE DRAINS**

**UPVC**



- RF836** PIPE DUCT 2M, 75MM
- RF847** PIPE DUCT 2M, 100MM



- RF387** WALL CAP 75MM ONE PIECE
- RF338** WALL CAP 75MM TWO PIECE
- RF848** WALL CAP 100MM ONE PIECE
- RF849** WALL CAP 100MM TWO PIECE



- RF839** PVC 90 DEGREE FLAT ELBOW 75 MM
- RF850** PVC 90 DEGREE FLAT ELBOW 100MM



- RF840** 90 DEGREE CORNER ELBOW 75MM
- RF851** 90 DEGREE CORNER ELBOW 100MM



- RF841** PVC CEILING CAP 75MM
- RF852** PVC CEILING CAP 100MM



- RF846** PVC 45 DEGREE FLAT ELBOW 75 MM
- RF856** PVC 45 DEGREE FLAT ELBOW 100MM



- RF842** PVC DUCT JOINER 75 MM
- RF853** PVC DUCT JOINER 100MM



- RF845** PVC END COVER 75 MM
- RF855** PVC END COVER 100MM



- RF843** FLEXI JOINT 75 MM, 500MM LONG
- RF844** FLEX JOINT 75MM, 1000MM LONG
- RF854** FLEX JOINT 100MM, 800MM LONG



- RF857** TEE JOINT 75 MM INC REDUCER
- RF858** PVC TEE JOINT 100MM



- RF859** PVC REDUCER 100MM TO 75MM



- RF814** MOUNTING BLOCK 450MM



- RF434B** 15MM DRAIN PIPE 3.9M
- RF434A** 20MM DRAIN PIPE 3.9M
- RF434C** 25MM DRAIN PIPE 3.9M
- RF434D** 32MM DRAIN PIPE 6M

**PVC FITTINGS**



**ELBOWS**

- RF445** 90° 15MM 1/2"
- RF430** 90° 20MM 3/4"
- RF430A** 90° 25MM 1"
- RF430B** 90° 32MM 1 1/4"
- RF430C** 90° 40MM 1 5/8"
- RF446** 45° 15MM 1/2"
- RF431** 45° 20MM 3/4"
- RF431A** 45° 25MM 1"



**REDUCING BUSHES**

- RF409** 20 X 15MM
- RF432** 25 X 20MM
- RF432A** 40 X 20MM
- RF432B** 40 X 32MM
- RF432C** 40 X 25MM
- RF432D** 32 X 25MM



**TEES**

- RF435A** 15MM 1/2"
- RF435** 20MM 3/4"
- RF435B** 25MM 1"
- RF435C** 32MM 1 1/4"
- RF435D** 40MM 1 5/8"



**DOUBLE END SOCKETS**

- RF410** 20MM 3/4"
- RF410A** 25MM 1"
- RF410B** 32MM 1 1/4"
- RF410D** 40MM 1 5/8"



**PRESSURE PIPE CLIPS**

- RF433** PVC 20MM
- RF433A** PIPE CLIP WITH ACCS.

**OTHER/GLUE/DEKTITE**



- RF436** DEKTITE 0-70 MM



- RF437** GLUE CLEAR SOLVENT

- RF437A** PIPE TYPE & CEMENT GLUE BLUE & CLEAR



- PPS084 15MM FULL SADDLE WHITE
- PPS106 20MM FULL SADDLE WHITE
- PPS143 25MM FULL SADDLE WHITE
- PPS168 32MM FULL SADDLE WHITE



**RE387E** WIRELESS RF UNIVERSAL A/C CONTROL SYSTEM



**RF395** REMOTE SENSOR WITH WALL MOUNT, PLUG & 10M LEAD

## UNIVERSAL REMOTES & PC BOARDS



- KT-208** A/C UNIVERSAL REMOTE (208 IN 1)
- KT-508** A/C UNIVERSAL REMOTE (508 IN 1)
- Q-988E** UNIVERSAL A/C REMOTE CONTROL



**RE387C** UNIVERSAL A/C ROOM CONTROL THERMOSTAT 10-30DEG



**RF407** EZT113 20MM

## CONDENSATE PUMPS



**RF428** MINI ORANGE CONDENSATE PUMP



**RE396C** AIRCONMISER COOLING ONLY

**RE396D** AIRCONMISER DUAL CYCLE

## HANWEST



**RE390** CONTROL SET WITH IOM CABLE A/C HAN-L62



**RF429** MINI AQUA CONDENSATE PUMP



**KT-E08** UNIVERSAL A/C REMOTE CONTROL 6000 IN 1



**RE387** UNIVERSAL A/C REMOTE WITH PC BOARD



**RE391** UNIVERSAL OUTDOOR UNIT CONTROLLER INCORPORATING DEFROST FUNCTION



**RF549** HI-FLOW TANK CONDENSATE 1L

**RF550** HI-FLOW TANK CONDENSATE 2L



**RE387A** UNIVERSAL A/C REMOTE WITH PC BOARD



**RE392** 6 ZONE RELAY BOARD IN ENCLOSURE TO SUIT RE390



**RF553** 240V SUNNY FLOWWATCH 12L SICCO



**RE387B** UNIVERSAL A/C REMOTE WITH PC BOARD



**RE393** REMOTE SENSOR WITH 5M LEAD

**RE394** REMOTE SENSOR WITH 10M LEAD



**RF555** 240V FLOWWATCH TANK 1.3L, 80W





RF554 240V MINI FLOWWATCH 2, 10L SICCOM

CLEAR VINYL PVC TUBING/DRAIN PIPE



PVC3MM	3MM 30M ROLL
PVC4MM	4MM 30M ROLL
PVC6MM	6MM 30M ROLL
PVC6MM/1	6MM 100M ROLL
PVC8MM	8MM 30M ROLL
PVC8MM/1	8MM 100M ROLL
PVC10MM	10MM 30M ROLL
PVC10MM/1	10MM 100M ROLL
PVC12MM	12MM 30M ROLL
PVC16MM	16MM 30M ROLL
PVC19MM	19MM 30M ROLL
PVC25MM	25MM 30M ROLL
PVC32MM	32MM 1M LENGTH

FLEXIBLE DRAIN PIPE



FDP16 CORRUGATED 16mm 50m



FDPS16 INSULATED 19mm 20m



RF438 DRAIN HOSE 16MM X 50M

COPPER ELBOWS

COPPER 45° ELBOWS



RF473R	3/8" R410A
RF473-12	1/2" R410A
RF467R	5/8" R410A
RF466R	3/4" R410A
RF467R	7/8" R410A
RF469	1"
RF469R	1" R410A
RF470	1 1/8"
RF470R	1 1/8" R410A
RF470-114	1 1/4"
RF471R	1 3/8" R410A
RF471-138	1 3/8"
RF471-112	1 1/2"
RF473R	1 5/8" R410A
RF473-158	1 5/8"

Copper 90° Elbows



RF351-14	1/4"
RF351BLR	1/4" LONG RADIUS
RF351	3/8" 9.5MM
RF351LR	3/8" LONG RADIUS
RF352	1/2" 12.7MM
RF352LR	1/2" LONG RADIUS
RF353	5/8" 15.9MM
RF353LR	3/8" LONG RADIUS
RF354	3/4" 19.1MM
RF354R	3/4" R410A
RF355	7/8" 22.2MM
RF355R	1/5" R410A
RF356	1" 25.4MM
RF356R	1" R410A
RF357	1 1/8" 28.6MM
RF357R	1 1/8" R410A
RF358-138	1 3/8" R22
RF358R	1 3/8" 35MM R410A
RF358RR	1 5/8" R410A
RF358-158	1 5/8" R22

COPPER TEES



RF411	1/4"
RF411-516-14	5/16" X 5/16" X 1/4"
RF411-516	5/16"
RF411-38-14	3/8" X 3/8" X 1/4"
RF412	3/8"
RF413-12-14	1/2" X 1/2" 1/4"
RF413-12-38	1/2" X 1/2" X 3/8"
RF413	1/2"
RF414-58-38	5/8" X 5/8" X 3/8"
RF414-58-12	5/8" X 5/8" X 1/2"
RF414	5/8"
RF415-34-38	3/4" X 3/4" X 3/8"
RF415-34-12	3/4" X 3/4" X 1/2"
RF415-34-58	3/4" X 3/4" X 5/8"
RF415	3/4"
RF416	7/8"
RF417-1-12	1" X 1" X 1/2"
RF417-1-34	1" X 1" X 3/4"
RF417	1"
RF418	1 1/8" X 1 1/8" X 7/8"
RF418-18	1 1/8"
RF418-18R	1 1/8" R410A
RF418-114	1 1/4"
RF418-138-78	1 3/8" X 1 3/8" X 7/8"
RF418-138	1 3/8"
RF418-138R	1 3/8" R410A
RF418-112	1 1/2"
RF418-158	1 5/8"

R410A COPPER COUPLINGS



RF489	1/4"
RF493	3/8"
RF494	1/2"
RF495	5/8"
RF495A	3/4"
RF492	7/8"
RF491	1"
RF490	1 1/8"

## COPPER FLARE WASHERS



RF950	1/4"
RF951	3/8"
RF952	1/2"
RF953	5/8"
RF954	3/4"

## COPPER P Trap



RF408	20MM & BRUSH
RF460	5/8" R410A
RF461	3/4" R410A
RF462	7/8" R410A
RF463	1 1/8" R410A
RF463-138	1 3/8"
RF463-158	1 5/8"
RF436-218	2 1/8"

## COPPER BONNETS



RF955	1/4"
RF956	3/8"
RF957	1/2"
RF958	5/8"
RF959	3/4"

## REDUCING COPPER COUPLINGS



ID X ID

RF38-14	3/8" X 1/4" R410A
RF12-14	1/2" X 1/4" R410A
RF12-38	1/2" X 3/8" R410A
RF58-38	5/8" X 3/8" R410A
RF58-12	5/8" X 1/2" R410A
RF34-38	3/4" X 3/8" R410A
RF34-12	3/4" X 1/2" R410A

## REDUCING COPPER COUPLINGS CONT

RF34-58	3/4" X 5/8" R410A
RF78-12	7/8" X 1/2" R410A
RF78-58	7/8" X 5/8" R410A
RF78-34	7/8" X 3/4" R410A
RF1-12	1" X 1/2" R410A
RF1-34	1" X 3/4" R410A
RF1-78	1" X 7/8" R410A
RF118-12	1 1/8" X 1/2"
RF118-58	1 1/8" X 5/8"
RF118-58R	1 1/8" X 5/8" R410A
RF118-34	1 1/8" X 3/4"
RF118-34R	1 1/8" X 3/4" R410A
RF118-78	1 1/8" X 7/8"
RF118-78R	1 1/8" X 7/8" R410A
RF118-1	1 1/8" X 1"
RF114-1	1 1/4" X 1"
RF138-58	1 3/8" X 5/8"
RF138-34	1 3/8" X 3/4"
RF138-78	1 3/8" X 7/8"
RF138-118	1 3/8" X 1 1/8"
RF112-114	1 1/2" X 1 1/4"
RF158-78	1 5/8" X 7/8"
RF158-118	1 5/8" X 1 1/8"
RF158-138	1 5/8" X 1 3/8"
RF158-138R	1 5/8" X 1 3/8" R410A

## BRASS FLARE UNIONS MALE BSP X MALE BSP



RF421	1/4"	RF424	5/8"
RF422	3/8"	RF425	3/4"
RF423	1/2"	RF426	7/8"

## SOLDER UNIONS



RF720	1/8" 3/16" 1/4" 5/16" 3/8" 1/2"
-------	---------------------------------

## FLARE NUTS

### FROST PROOF NUTS



RF388A	1/4"
RF389A	3/8"
RF390A	1/2"
RF391A	5/8"
RF392A	3/4"

### SHORT BARREL NUTS



RF388	1/4"	RF391	5/8"
RF389	3/8"	RF392	3/4"
RF390	1/2"	RF393	7/8"

## MALE FLARE X FEMALE FLARE



RF14MF-14FF	1/4" x 1/4"
RF14MF-516FF	1/4" X 5/16"
RF14MF-38FF	1/4" X 3/8"
RF14MF-12FF	1/4" X 1/2"
RF516MF-14FF	5/16" X 1/4"
RF38MF-14FF	3/8" X 1/4"
RF38MF-38FF	3/8" X 3/8"
RF38MF-12FF	3/8" X 1/2"
RF12MF-14FF	1/2" X 1/4"
RF12MF-38FF	1/2" X 3/8"
RF12MF-58FF	1/2" X 5/8"
RF58MF-12FF	5/8" X 1/2"
RF58MF-34FF	5/8" X 3/4"
RF34MF-58FF	3/4" X 5/8"

DOUBLE MALE FLARE



RF701-516-14	5/16" x 1/4"
RF701-516-516	5/16" x 5/16"
RF701	3/8" x 1/4"
RF701-38-38	3/8" x 3/8"
RF702	1/2" x 1/4"
RF702-12-12	1/2" x 1/2"
RF703	1/2" x 3/8"
RF704	5/8" x 3/8"
RF705	5/8" x 1/2"
RF705-58-58	5/8" x 5/8"
RF706	3/4" x 1/2"
RF707	3/4" x 5/8"
RF707-34-34	3/4" x 3/4"

FEMALE FLARE X FEMALE FLARE



RF14FF-14FF	1/4" x 1/4"
RF38FF-38FF	3/8" x 3/8"
RF12FF-12FF	1/2" x 1/2"

MALE BSP X FEMALE BSP



RF14BSP-18BSB	1/4" x 1/8"
RF14BSB-38BSB	1/4" x 3/8"
RF38BSB-14BSB	3/8" x 1/4"
RF12BSB-14BSB	1/2" x 1/4"
RF12BSB-38BSB	1/2" x 3/8"
RF34BSB-12BSB	3/4" x 1/2"
RF1BSB-34BSB	1" x 3/4"

BRASS ELBOWS & TEES

TEES



RF710	1/4"
RF711	3/8"
RF712	1/2"
RF713	5/8"
RF714	3/4"

ELBOWS  
MALE FLARE X MALE BSP



RF14E-18E	1/4" X 1/8"
RF14E-14E	1/4" X 1/4"
RF14E-38E	1/4" X 3/8"
RF38E-18E	3/8" X 1/8"
RF38E-14E	3/8" X 1/4"
RF38E-38E	3/8" X 3/8"
RF38E-12E	3/8" X 1/2"
RF12E-38E	1/2" X 3/8"
RF12E-12E	1/2" X 1/2"
RF58E-12E	5/8" X 1/2"
RF34E-34E	3/4" X 3/4"

BRASS PLUGS, CAPS &  
SWIVEL UNIONS  
SEAL CAPS

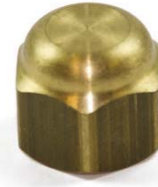

RF-14C	1/4"
RF-516C	5/16"
RF-38C	3/8"
RF-12C	1/2"
RF-58C	5/8"

PIPE SEAL PLUGS



BSP

RF965	1/4"
RF966	3/8"
RF967	1/2"
RF968	5/8"
RF969	3/4"

NPT

RF969-14	1/4"
RF969-38	3/8"
RF969-12	1/2"

BRASS SWIVEL CONNECTORS



RF960	1/4"
RF961	3/8"
RF962	1/2"
RF963	5/8"
RF964	3/4"

Go to  
**stareast.com.au**  
For new product updates  
and realtime product on-  
line purchasing.

## RUN CAPACITORS



450VAC

CAP002	2µF
CAP00275	2.75µF
CAP003	3µF
CAP0035	3.5µF
CA060A	4µF
CAP004S	4µF WITH SCREW
CAP004W	4µF WITH WIRES
CAP005	5µF
CAP005G	5µF ALUMINIUM
CAP006	6µF
CAP006G	6µF ALUMINIUM
CAP006S	6µF WITH SCREW
CAP007	7µF
CAP007S	7µF WITH SCREW
CAP007SA	7µF 2 PIN & STUD
BEN009A	8µF
CAP008G	8µF ALUMINIUM
CAP008S	8µF WITH SCREW
BEN009	10µF
CAP010G	10µF ALUMINIUM
CAP010S	10µF WITH SCREW
CAP012	12µF
CAP012S	12µF WITH SCREW
CAP014	14µF WITH SCREW
BEN010	16µF
CAP018	18µF WITH SCREW
CAP020	20µF WITH SCREW
CAP020G	20µF ALUMINIUM
CAP025	25µF
CAP025G	25µF ALUMINIUM
CAP030	30µF
CAP030G	30µF ALUMINIUM
CAP035	35µF WITH SCREW
CAP035G	35µF ALUMINIUM
CAP040	40µF
CAP040G	40µF ALUMINIUM
CAP045	45µF WITH SCREW
CAP045S	45µF WITH SCREW
CAP045A	45µF ALUMINIUM
CAP050R	50µF
CAP055A	55µF ALUMINIUM
CAP060A	60µF
CAP060R	60µF ALUMINIUM
CAP065	65µF ALUMINIUM
CAP069	69µF
CAP070	70µF
CAP075	75µF
CAP080A	80µF ALUMINIUM
CAP098	98µF

## START CAPACITORS



220VAC

SCO008	60-72µF
SCO009	64-77µF
SCO010	80-96µF
SCO010A	88-108µF
SCO011	108-130µF
SCO012	124-149µF
SCO013	145-175µF
SCO014	161-193µF
SCO015	192-228µF
SCO016	270-324µF
250VAC	
CAP047	47-56µF
CAP056	60-80µF
CAP060	60-80µF
CAP080	80-105µF
CAP088	88-108µF
CAP108S	130µF WITH SCREW
CAP124S	149µF WITH SCREW
CAP145S	175µF WITH SCREW
CAP161S	193µF WITH SCREW
CAP192S	228µF WITH SCREW
330VAC	
SCO001	53-70µF
SCO002	56-72µF
SCO003	72-88µF
SCO003A	88-108µF
SCO004	108-130µF
SCO005	124-149µF
SCO006	189-227µF
SCO007	216-259µF

## SQUARE A/C CAPACITORS



CAC1.5UF	1.5µF
CAC1UF	1µF
CAC2UF	2µF
CAC2.5UF	2.5µF
CAC3UF	3µF
CAC3.5UF	3.5µF
CAC4UF	4µF
CAC4.5UF	4.5µF
CAC5UF	5µF
CAC5.5UF	5.5µF

## SQUARE A/C CAPACITORS

CAC6UF	6µF
CAC7UF	7µF
CAC8UF	8µF
CAC9UF	9µF
CAC10UF	10µF
CAC11UF	11µF
CAC12UF	12µF

## OVAL TWIN CAPACITORS



370VAC

CAP0200	20µF+ 5µF
CAP020AO	20µF+15µF
CAP0250	25µF+3µF
CAP0300	30µF+5µF
CAP030AO	30µF+7.5µF
CAP0350	35µF+5µF
CAP0400	40µF+5µF
CAP0450	45µF+5µF
CAP0500	50µF+5µF
CAP050AO	50µF+7.5µF
CAP0550	55µF+7.5µF
CAP0650	65µF+7.5µF
440VAC	
CAP040BO	40µF+5µF
CAP050BO	50µF+5µF
CAP050CO	50µF+7.5µF
CAP0600	60µF+7.5µF

## OVAL CAPACITORS



370VAC

RCO001	25+10µF
RCO002	30+3µF
RCO003	30+5µF
RCO004	30+7.5µF
RCO005	35+3µF
RCO006	35+5µF
RCO007	35+7.5µF
RCO008	35+70µF
RCO009	40+5µF
RCO010	55+5µF
RCO011	55+7.5µF
RCO012	60+10µF



OVAL CAPACITORS

RCO013	35+5µF
RCO014	35+7.5µF
RCO015	40+5µF
RCO016	40+7.5µF
RCO017	45+5µF
RCO018	45+7.5µF
RCO019	50+5µF
RCO020	55+5µF
RCO021	55+10µF
RCO022	60+5µF

TWIN ROUND CAPACITORS



370VAC

RCO023	25+5µF
RCO024	30+3µF
RCO025	30+5µF
RCO026	35+5µF
RCO027	40+5µF
RCO028	45+5µF
RCO029	80+5µF
RCO030	80+7.5µF

440VAC

RCO031	35+7.5µF
RCO032	35+10µF
RCO033	40+5µF
RCO034	40+7.5µF
RCO035	40+10µF
RCO036	45+5µF
RCO037	45+7.5µF
RCO043	60+5µF
RCO044	60+7.5µF
RCO045	80+5µF
RCO046	80+7.5µF
RCO047	80+10µF

MAPP & OXY SETS

TS8000	TORCH KIT WITH FAT BOY
TS4000	TORCH KIT WITH FAT BOY
4652B	TORCH KIT STAND ALONE TS8000



4652C T-A HAND TORCH WITH ELECTRICAL IGNITION

MAPP & OXY SETS continue



4652D T-B HAND TORCH NO ELECTRICAL IGNITION



BZ8250HT TRIGGER START HOSE TORCH WITH FUEL HOLSTER



MG9 CYLINDER MAPP GAS 479 16.92OZ



TSCGA600 MICROTORCH CGA600 IN BLISTER



OXY001 OXY SET KIT INCL. MAPP GAS & OXYGEN



OXY005 OXYGEN BOTTLE 1 LITRE



RF055 MAPP GAS 3600DEG/F 14.1OZ/399.7G



OXY0010 OXY STAR TIPS FOR OT200 (4 NOZZLES)



OXY009 REPLACEMENT SEAL FOR OXYGEN



T134 FLAME STOP PAD/HEAT PAD

MAPP & OXY SET PRODUCT PHOTO SUBJECT TO CHANGE WITHOUT NOTICE. PHOTOS ARE FOR GUIDE ONLY. PLEASE ASK ONE OF OUR STAFF FOR MORE DETAILS.

ARE YOU AFTER SPARE PARTS FOR YOUR OXY SET. JUST ASK FOR A DATA SHEET AND ORDER THE SPARE PART YOU REQUIRE.



BLACK DIAMOND  
PROFESSIONAL & HIGH QUALITY

**Smart Spring Design**

Addition of a spring as part of the cutter greatly improves cutting action.

With a spring, constant pressure is applied to the tube. Once tightened, the knob does not need to be adjusted again because the tightness is always maintained. Also, non-round tubes can now be cut because the spring automatically adjusts the blade to the shape of the tube. The spring also relieves pressure from the blade, making the blade last longer and creates a smooth, effortless cutting motion.

**Center Channel**

When a blade cuts into the tube, the side walls of the blade track will be pushed outwards. Traditional rollers flatten the walls as the cutter is turned. The flattened walls damage the blade and the roller by scratching the surface.

A center groove on the roller prevents the track from being flattened. Therefore, blade and roller life are prolonged because there is no longer friction between their surface and the blade track.

**TPR Handles**

Patented TPR knob and handles on all products gives a good tactile feedback and is easy to trip. Multiple colors are available for all aesthetic needs.



RF11318 HEAVY DUTY SPRING LOADED TUBE CUTTER



RF14206 FLARING TOOL, LIGHT WEIGHT  
1/4,5/16,3/8,5/8,3/4  
ADAPTOR  
1/4,3/8,5/16,1/2,5/8,3/4

BLACK DIAMOND  
PROFESSIONAL & HIGH QUALITY



RF12999 MULTI SIZE TUBE BENDER, 1/4,  
5/16, 3/8, 1/2,5/8,3/4,7/8



RF13800 EXPANDER KIT  
1/4,3/8,1/2,5/8,3/4, 7/8,1,1-1/8



RF11117 REVERSE MINI SPRING LOADED TUBE CUTTER

RF11118 TITANIUM PLATED BLADE

RF11115 NICKEL PLATED BLADE

RF11116 TITANIUM FINISHING BLADE



RF11211 NICKEL PLATED BLADE

RF11212 TITANIUM FINISHING BLADE



RF12106 3/8 QUICK ACTION TUBE BENDER

RF12108 1/2 QUICK ACTION TUBE BENDER

RF12110 5/8 QUICK ACTION TUBE BENDER



RF14505 FLARING TOOL, LIGHT WEIGHT  
WITH POLISHED CONE  
1/4,,3/8,1/2,5/8,3/4



RF14535 FLARING TOOL, LIGHT WEIGHT  
WITH TUBE & POSITIONING  
DEVICE 1/4,,3/8,1/2,5/8,3/4



WHY BUY  
BLACK DIAMOND  
PROFESSIONAL TOOLS  
TRY & DISCOVER THE  
DIFFERENCE



**REFRIGERANT CHARGING EQUIPMENT AND CYLINDER ACCESORIES**



- CH1000 NITROGEN REGULATOR 0-1000KPA DOMESTIC
- CH6000 NITROGEN REGULATOR 0-6000KPA COMMERCIAL



RF162A GAS CAP



- CG-31-H REFRIGERANT CHARGING CYLINDER R134A +50W HEAT
- CG-31-S REFRIGERANT CHARGING CYLINDER R134A



RF216A2-1 1/4 BRASS BRANCH TEE WITHOUT DEPRESSOR

RF216A2 1/4 BRASS BRANCH TEE WITH DEPRESSOR



RF721 VALVE CORE REMOVER INSTALLER 1/4" AND 5/16"

RF721A VALVE CORE REMOVER INSTALLER 1/4" AND 3/8"



RF162 CYLINDER ADAPTOR 1/4 MALE X 3/4 FEM



RF215 ADAPTOR 1/4-5/16 SIZE FOR VAC PUMP

RF214 ADAPTOR 5/16-1/4 SIZE FOR VAC PUMP



T098B SYSTEM FLUSH KIT



RF498 1/4-5/16 R410a R22 ADAPTOR & SHUT OFF VALVE

**RECLAIM UNITS**



SV86 PROMAX RECLAIM RECOVERY UNIT R134A R22 R410A

SV97 MINI RECOVERY 3/4HP

SV98 MINI RECOVERY 1HP

SV99 RECOVERY UNIT 1/2HP

SV96 RECOVERY UNIT 1HP

**VACUUM PUMPS, REFRIGERATION OILS & VACUUM GAUGES**



SV91 6.0CFM 3/4HP 16.5KG

SV91SV 6.0CFM 3/4HP 16.5KG

SV92N 7.0CFM 3/4HP 15.9KG

SV92SV 6.0CFM 3/4HP 15.9KG

SV93SV 4.0CFM 1/2HP 10.5KG

SV94SV 8.0CFM 1HP 16.3KG

SV95N 5.0CFM 1/2HP 10.5KG

**VACUUM PUMPS, OILS & VACUUM GAUGES CONTINUED**



DV3E-250 J/B VACUUM PUMP 85 LITRES PER MIN (ELIMINATOR)

DV4E-250 J/B VACUUM PUMP 113 LITRES PER MIN (ELIMINATOR)

DV6E-250 J/B VACUUM PUMP 142 LITRES PER MIN (ELIMINATOR)



DV-41 SUPERNOVA VACUUM GAUGE WITH CASE



DV-24N DIGITAL VAC GAUGE AND CASE



DV42N 36L/MIN PLATINUM

DV85N 72L/MIN PLATINUM

DV142N 120L/MIN PLATINUM

DV200N 170L/MIN PLATINUM

DV285N 242L/MIN PLATINUM

DVO-12 QUART BOTTLE VAC PUMP OIL (946ML)

DVO-24 GALLON BOTTLE VAC PUMP OIL (3.78L)



VP-2120 VAC PUMP 6 PORT HEAVY DUTY

## TUBE BENDERS



CH-404 MULTI SIZE TUBING BENDER

CH-404L MULTI SIZE TUBING BENDER



CH-666 TUBE BENDER 1/4" 5/16" & 3/8" ALL IN 1



TB1/2 1/2"

TB1/4 1/4"

TB3/4 3/4"

TB3/8 3/8"

TB5/8 5/8"

TB7/8 7/8"



SE-R05F038 TUBE EXPANDER KIT 3/8-1 1/8"

## SPRING BENDERS



CT-102-04 1/4 X 10"

CT-102-05 5/16 X 10"

CT-102-06 3/8 X 10"

CT-102-08 1/2 X 12"

CT-102-10 5/8 X 14"

CT-102-12 3/4 X 14"

CT-102-14 7/8 X 14"

## TUBE EXPANDERS (SWAGING)



CH-1001 3/8" HEAD

CH-1002 1/2" HEAD

CH-1003 5/8" HEAD

CH-1004 3/4" HEAD

CH-1005 7/8" HEAD

CH-1006 1" HEAD

CH-1007 1 1/8" HEAD

CH-1008 1 3/8" HEAD



CH-1000B-P Tube Expander 3/8;1/2;5/8;3/4;7/8;1 & 1 1/8 INCH

CH-100B-HY HYDROLIC EXPANDER 3/8-1 1/8

## TUBE, PIPE & HOSE CUTTERS



TC18 1/8" - 5/8" TUBE CUTTER RED

TC78 1/8" - 7/8" TUBE CUTTER RED

TC127 1/8" - 5/8" TUBE CUTTER SILVER

CH-170 HEAVY DUTY CUTTER 1/8-1 1/2" OD



TC-127 TUBE CUTTER 1/8 TO 5/8 OD SMALL MINI



TC-312B SPARE TUBE CUTTERS FOR TC-274 9PK

## TUBE, PIPE & HOSE CUTTERS



TC-110 RATCHET-ACTION PIPE CUTTER 5/16 - 1 1/8"



CT-128 CAPILLARY TUBE CUTTER



VF-32 HOSE CUTTER 32MM STANDARD



PC-35 PVC PIPE CUTTER 35MM 1 3/8" SK-5 LY-998

PC-42 PVC PIPE CUTTER 42MM 1 5/8" SK-5 LY-999

## JB MANIFOLD



10-540A ZEPPELIN 2 VALVE MANIFOLD R410A

10-568A ZEPPELIN 2 VALVE MANIFOLD R404A & R134A

10-567A ZEPPELIN 2 VALVE MANIFOLD R404A & R134A



**JB MANIFOLD**



RFM221126	BRASS 2V MANIFOLD R134/22/404 1/4"FL
RFM221132	BRASS 2V MANIFOLD R134/22/404 1/4"FL + 5' RBY HOSES
RFM221526	BRASS 2V MANIFOLD R410a 5/16"FL
RFM221532	BRASS 2V MANIFOLD R410a 5/16"FL + 5' RBY HOSES
RFM421126	BRASS 4V MANIFOLD R134/22/404 1/4"FL
RFM421132	BRASS 4V MANIFOLD R134/22/404 1/4"FL + 5' RBY HOSES
RFM421526	BRASS 4V MANIFOLD R410a 5/16"FL
RFM421532	BRASS 4V MANIFOLD R410a 5/16"FL + 5' RBY HOSES

**JB ZEPPELIN MANIFOLD**



RF24126	2V MANIFOLD R134/22/404 1/4"FL
RF24526	2V MANIFOLD R410a 5/16"FL
RF24110	2V MANIFOLD R134/22/404 1/4"FL + 5' RBY HOSES
RF24502	2V MANIFOLD R410a 5/16"FL + 5 RBY HOSES
RF25126	4V MANIFOLD R134/22/404 1/4"FL
RF25506	4V MANIFOLD R410a 5/16"FL
RF25127	4V MANIFOLD R134/22/404 1/4"FL + 5' RBY HOSES
RF25510	4V MANIFOLD R410a 5/16"FL + 5' HOSES

**MANIFOLDS, GAUGES & HOSES**



CT-536G	MANIFOLD SET WITH HOSES & SIGHT GLASS R12;R22;R134A KPA
CT-636G	MANIFOLD SET & HOSES R12;R22;R134A

**MANIFOLDS, GAUGES & HOSES**



RG-250	REFRIG GAUGE R12; R22 & 502 BLUE
RG-501	REFRIG GAUGE R12; R22 & R134A RED
RG-252	REFRIG GAUGE L/P 80MM R22; R134A; R404
RG-251	REFRIG GAUGE R12; R22; & R134A BLUE



CT336RYB	3 SET HOSES ALL GASES 36 0.9M
CT372RYB	3 SET HOSES ALL GASES 72 2M
CT396RYB	3 SET HOSES ALL GASES 96 2.4M



CH-79583	(R) 3 RUBBER & DEPRESSOR MANIFOLD
CH-79584	(L) GASKET HOSE REPAIR 6PCS RUBBER



CT-BLUE	MANIFOLD PROTECTOR BLUE RUBBER
CT-RED	MANIFOLD PROTECTOR RED RUBBER

**LEAK DETECTORS**



TIFRX-1A	ELECTRONIC LEAK DETECTOR SPX & S#
TIFXL-1A	ELECTRONIC LEAK DETECTOR SPX

**LEAK DETECTORS CONTINUE**



CPU-1G	HALOGEN LEAK DETECTOR ELECTRONIC
--------	----------------------------------



LD-5000	PROWLER REFRIGERANT GAS LEAK DETECTOR
---------	---------------------------------------



TIFXP-2	REPLACEMENT TIP PROTECTOR 3 TIPS
---------	----------------------------------

**BIG EZ UNIVERSAL DYE INJECTION**



RFBEZ400ECS	UNIVERSAL DYE INJECTION KIT
RFBEZ4ECS	UNIVERSAL/POE CARTRIDGE 118ML

**AR-GLO BOTTLED DYE**



RFARGLO4EP	473ML BOTTLE
RFARGLO4E	59ML BOTTLE

**DYE KITS**



T110	SINGLE APPLICATION UV DYE 7.5ML
T111	UV DYE, 32 DOSES, 237ML

## DYE KITS



**T099** INJECTOR 1/4F 60ML CAPACITY

**T099A** INJECTOR 1/4F 15ML CAPACITY



**RFVHC22008** LEAK DETECTOR L/T 8OZ

**RFVHC22032** LEAK DETECTOR L/T 32OZ



**T098** UV LAMP & GOGGLES 1W HIGH POWER LED



**T097** UV LEAK DETECTION KIT & GOGGLES

## EZ-JECT KIT COMPLETE



**RFOPK40EZE** EZ-JECT UV KIT W/ OPX400CS

**RFOPK50EZE** EZ-JECT UV KIT W/ OPX500CS



**RF183** ACR SUPER SEAL FRIDGE .07-5.3KW (.1-7HP)

**RF183A** ACR SUPER SEAL PRO R134A, R12 ON AUTOS

**RF184** ACR SUPER SEAL HVACR 5.3-17.6KW (7-23HP)

**RF184A** ACR SUPER SEAL 3PHASE MIN 17.6KW (23HP)

**RF184B** TOTAL ONE SUPER SEAL & COLOUR DYE

## FLARING, SWAGING & DEBURRING TOOLS



**CH-609AML** FLARING TOOL KIT 1/4 - 3/4" WITH 5 YEAR GUARANTEE



**CH-809AML** 1/4 - 3/4" FLARING/CUTTING KIT



**CH-275L** FLARING TOOL WITH HANDY CARRY CASE

**CH-278L** FLARING TOOL KIT & SWAGING TOOL



**CT-806A** FLARING TOOL 1/4- 3/4



**LY-203** FLARING TOOL LARGE FOR 5/8,3/4,7/8,1 1/8



**CH-193** SWAGING TOOLS

## SPRING BENDERS



**CT-102-04** 1/4 X 10"

**CT-102-05** 5/16 X 10"

**CT-102-06** 3/8 X 10"

**CT-102-08** 1/2 X 12"

**CT-102-10** 5/8 X 14"

**CT-102-12** 3/4 X 14"

**CT-102-14** 7/8 X 14"



**CH-208** INSIDE & OUTSIDE REAMER 3/16" TO 1-1/2" PLASTIC SUITS ALL KITS

**LY-208** INSIDE & OUTSIDE REAMER 1/8" TO 1-5/8"



**CH-209AL** 5/16 - 2 3/8" ALUMINIUM REAMER LARGE



**CH-94** 3-IN-1 SWAGING PUNCH 1/2", 5/8" & 7/8"

**CH-96** 3-IN-1 SWAGING PUNCH 5/8", 7/8" & 1 1/8"

**CH-95** 5IN1 SWAGING PUNCH



**DT-100** DEBURRING TOOL LARGE & BACKUP SPARE YELLOW

**DT-300** DEBURRING TOOL POCKET ALUMINIUM RED

**DT-400** DEBURRING TOOL YELLOW



**INSPECTION MIRRORS**



M2 INSPECTION MIRROR 2" DIAM



M3 INSPECTION MIRROR 2" X 3 1/2"



M4 INSPECTION MIRROR 1 1/4" DIAM



M5 INSPECTION MIRROR 1" X 2"



BT-401 BRUSH CLEANING TOOL 1/2" & 3/4" OD BLACK

**FIN STRAIGHTENERS**



CH-352 STAINLESS STEEL SMALL



CH-353 STAINLESS STEEL LARGE

**PLIERS**



SF4311 PIERCING PLIERS  
CH-308 PIERCING PLIERS SEI



CH-342 PIERCING PLIERS SEI VAPOUR SEAL

CH-343 PIERCING PLIERS SEI



4502 HOSE CLAMP PLIERS SET OF 2



PH-303 7" PINCH OFF PLIERS

**RATCHET WRENCHES**



RW-122 A/C HEX; 3/16 1/4 5/16 3/8



RW-123 A/C HEX; 3/16 1/4 SQ 12 9/16 STRAIGHT

**SCREWDRIVERS**



FJS-250 4 IN ONE QUICK CHANGE



T094 6IN1 RATCHET HEAVY DUTY



CH-RC1 AVIATION SNIPS LEFT CUT SCROLL SHEARS

CH-RC3 AVIATION SNIPS STRAIGHT CUT SCROLL SHEARS

**OTHER**



CH-138 CAR AIR CON SET WITH ADAPTORS ACC

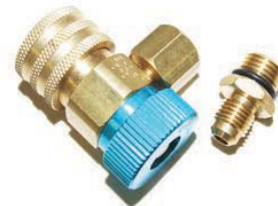

QC-H FEMALE RED QUICK COUPLER 14MM H.P

QC-L FEMALE BLUE QUICK COUPLER 14MM L.P



T114 PPS, CLEAR GLASS WITH BLACK FRAME UVEX

## MULTIMETERS & OTHER TESTERS



**QP2000** TESTER POWER POINT & EARTH LEAD



**QM-1644** HAND-HELD ANEMOMETER WITH TRIPOD STAND



**QM-7225** POCKET INFRARED THERMOMETER 1:1 OPTICS



**TM-181** TEMPERATURE & HUMIDITY TESTER



**QM-7298** ALCOHOL BREATH TESTER



**WT-2** DIGITAL THERMO WITH S/S SENSOR PROBE



**QP2295** METER DISTANCE ULTRASONIC H/DUTY



**QM-1524** CAT II AUTORANGING DMM



**RT-902** DIGITAL TEMP WITH S/S SENSOR -50 - 200°



**QM-1592** PRO SOUND LEVEL METER WITH CALIBRATOR



**QM-1549** IP67 TRUE RMS AUTORANGING CAT IV DMM



**UT12A** VOLTAGE TESTER BUZZER

**UT12B** VOLTAGE TESTER BUZZER AUTO



**XC-5078** 2 IN 1 NETWORK CABLE TESTER AND DIGITAL MULTIMETER



**QM-1571** IP67 TRUE RMS AUTORANGING CAT IV DMM WITH WIRELESS USB



**MS6115** MAINS LCD POWER METER READING



**QP-2286** ELECTRICAL TESTER WITH POLARITY CHECKING & LIGHT



**QM-1592** PRO SOUND LEVEL METER WITH CALIBRATOR



**TS-1465** 25W SOLDERING IRON

**TS-1466** SPARE TIP

MISCELLANEOUS TOOLS & OTHER EQUIPMENT  
SCALES



EC3000-100 ELECTRONIC REFRIG SCALES - 100KG

EC3000-120 ELECTRONIC REFRIG SCALES - 120KG



ADS-100 ELECTRONIC SCALE 100KG



TIF9010A 55KG SCALE IN CASE

CLAMP METERS



TM-13E AC/DC AUTO POWER OFF & ZERO H/DUTY

TM-16E DIGITAL NEW TYPE



ACD-14 CLAMP METER AMPROBE DUAL DISPLAY 3000UF



YF-8020 DIGITAL TYPE

YF-8070 DIGITAL TYPE H/DUTY

AMPROBE HVAC/R



34XP-A AVERAGING MULTIMETER



34XR-A TRUE RMS PROFESSIONAL MULTIMETER



IR608A INFRARED THERMOMETER



MAN02 NANOMETER IN BLACK CASE



TH1 TEMP/RH POCKET THERMOMETER



THWD-5 PROFESSIONAL TEMP/RH METER



TMA-10A ANEMOMETER



TMD-10 DUAL CHANNEL THERMOMETER



TPP2-C1 SURFACE TEMP POCKET PROBE



VPC-10N VOLTAGE & CONTINUITY TEST/ PROBE AMPROBE



ACD-14 CLAMP METER AMPROBE DUAL DISPLAY 3000UF

SPECIAL TRACKER



LA-9011 GPS/GSM TRACKING DEVICE FOR CARS, BOATS & TRUCKS





PR-005 HEX KEY SET 3/32 1/8 5/32 3/16



HP0638 SPRING ASSORTMENT 200PC



T119 REST OF KITS AND SEI TOOLS



STW-07 SPANNER TORQUE WRENCH KIT



CH-237 CORE TOOLS REPAIR KIT IN CASE



HH600-12 600PC HOME HARDWARE ASSORTMENT



YS-03DE TERMINAL CRIMPING TOOL NON INSULATED

YS-03FC TERMINAL CRIMPING TOOL FOR 6.35MM & INSULATED



T122 29PCS HAND TOOLS SET



TPB105-18 SHRINK TUBE TERMINAL KIT 105PCS



TD004 O RING KIT 240 PCS



T121 SPANNER TORQUE WRENCH KIT



TD005 127PC SHRINKABLE TUBING ASSORTMENT



TD004A O RING KIT 30 SIZE 382 PCS

TD004B O RING KIT 30 SIZE 386 PCS



T123 SPANNER TORQUE WRENCH KIT



LW350-12 LOCK&FLAT WASHER 350PCS



LW350-12 LOCK & FLAT WASHER 350PCS



T120 SPANNER TORQUE WRENCH KIT



LW350-12 LOCK&FLAT WASHER 350PCS



GA125-18 125 GROMMET ASSORTMENT



UW1 6 IN 1 MINI L WRENCH



SHB-530B HAND BLOWER 220V



HB-6355 FOAM INSERT ALUMINIUM AT-TACHE CASE (SMALL)

HB-6356 FOAM INSERT ALUMINIUM AT-TACHE CASE (LARGE)



ST-3452 90 LUMEN CREE® LED TORCH



GH-1393 MULTI-FUNCTION WET & DRY AUTO VACUUM



ST-3463 SUPER BRIGHT LED TORCH WITH MAGNETIC HEAD AND TELESCOPIC NECK



YS-2815 PORTABLE TOILET



RFR31 1LT VAC PUMP OIL R31

RFR31 4LT VAC PUMP OIL R31

RFGUFA5 5LT UNIVERSAL FLUSH FLUID

RFGUFA20 20LT UNIVERSAL FLUSH FLUID

RFGUFA200 200LT UNIVERSAL FLUSH FLUID



RFGLY20 20LT PROPYLENE GLYCOL USP

GLY200 200LT PROPYLENE GLYCOL USP



RFT30251 OIL TRANSFER PUMP



RFBRZ1000 BRAZE-RITE ADAPTER



RF97795 MIGHTY PUMP

VETO PRO PAC



RFVETO-TECHLC TECH-LC LARGE TOOL BAG W: 24CM L: 35CM H: 31CM 2.5KG (EMPTY)



RF571A HVAC TEST METER TOOL BAG W: 7.5CM L: 20.5CM H: 25CM 1KG (EMPTY)

RF571 HVAC 3 POCKET TOOL BAG W: 12CM L: 20CM H: 24CM 1.3KG (EMPTY)



RFVETOTECH-PAC1 HVAC BACK PACK TOOL BAG W: 25CM L: 36CM H: 55CM 4.2KG (EMPTY)



RFVETOLC LARGE CLOSED TOOL BAG W: 24 L: 34CM H: 30CM 3.3KG (EMPTY)

PAINTS, TAPES, GLUES & ACCESSORIES  
PAINTS



T022 STAREAST 300G APPLIANCE WHITE



## ELECTRICAL TAPE



**T021** ELECT TAPE PVC INSULATION  
Colours: Black/White/Blue/Red/Green/Yellow



**RF437** CLEAR SOLVENT 100G  
**RFN070500** CLEAR SOLVENT 500G

## DUCT TAPE



**T033** 48MM X 30M SILVER 550/13  
**T033A** 50MM X 20M SILVER  
**T033H** 48MM X 30M SILVER STYLUS  
**T034** 48MM X 30M BLACK 550/13

## ALUMINIUM TAPE



**T024** ALUMINIUM TAPE FOIL SILVER 48MM X 45M

## SELF-ADHESIVE TAPE



**PR-260** STRONG ADHESION 2" X 60YDS  
**T021A** HYSTIK 24MM X 50M  
**T021B** HYSTIK 18MM X 50M  
**T021C** HYSTIK 36MM X 50M  
**T024** 48MM X 45M SMOOTH  
**T024A** 48MM X 45M FIBREGLASS  
**T024B** 48MM X 9.14M BLACK

## CONTACT ADHESIVE



**T043B** PATTEX 50G HEAVY DUTY  
**T043C** PATTEX 125G HEAVY DUTY



**T043F** REPAIR EVAPORATORS AND CONDENSORS ENAMAX



**T043L** LOCTITE HOLDTITE JET SET 25G



**PVCFRC01** PVC FUSION CAN TO JOIN PVC PIPE

## OTHER



**T081** COOL GEL; HEAT SPRAY 473ML



**T082** EPOXY STICK 113G



**T083** VISU-GLOW LEAK DETECTOR 236ML



**T113** MIZU FOAM CLEANS AIR COILS



**T115** BLAST-A-COIL AEROSOL 18OZ CLEANER



**T116** COAT-A-COIL AEROSOL 18OZ PROTECTOR



**T117** LEAK LOCK



**T118** GREEN STUFF COIL CLEANER



RF55904 LOW V.O.C. PVC SOLVENT CE-  
MENT 473ML

RF55906 LOW V.O.C. PVC SOLVENT CE-  
MENT 946ML



RF65554 BETTER BUBBLE LEAK  
LOCATOR 237ML SPRAY

RF65432 BETTER BUBBLE LEAK  
LOCATOR 946ML TRIGGER



RF96500 DRAFT-BLOCK EXPANDING  
FOAM SEALANT 354ML



RF55914 PURPLE-LOW V.O.C. PRIMER  
473ML



RF97685 NU-LINE A/C CONDENSATE  
DRAIN CLEANER 237ML

RF97690 NU-LINE A/C CONDENSATE  
DRAIN CLEANER 946ML



RF82500 COMPLETE KIT 473ML TURBO  
KLEEN WITH  
INJECTOR, NOZZLE & FLUSH-  
ING TOOL

RF82400 TURBO KLEEN HVAC/R FLUSH  
473ML

RF82450 TURBO KLEEN HVAC/R FLUSH  
3.8L



RF45004 ACID AWAY COMPRESSOR  
BURNOUT ACID  
NEUTRALIZER 118ML

RF45010 ACID AWAY COMPRESSOR  
BURNOUT ACID  
NEUTRALIZER 30ML

RF45009 ACID AWAY FOR POE ACID  
NEUTRALIZER 118ML



88312 NICKEL-SAFE ICE MACHINE  
CLEANER FOOD GRADE 473ML

88314 NICKEL-SAFE ICE MACHINE  
CLEANER FOOD GRADE 3.8L

88438 K.O. DIRT BLASTER 200Z



T135 THAWZONE 10Z 28ML MOISTURE  
CONTROL



RF45002 ACID DETECTOR TEST KIT

RF45006 ACID TEST KIT FOR POE



RF86312 SILENT RUN 118ML



RF45001 OIL I.D. KIT



RF40500 GOJO HAND CLEANER TUB

RF40507 GOJO HAND CLEANER 414ML  
BOTTLE

Have you registered on our website?  
Do you receive our monthly emails?  
You are missing out on extra technical data and pricing!

Go to **stareast.com.au**  
For up to date products offered and regular new products updates

## COMPRESSORS: DOMESTIC



RFN051	AQAW51X	170-219L		
RFN057	AQAW57X	220-299L		
RFN066	AQAW66X	250-350L	1/5HP	6.55DISP
RFN077	AQAW77X	350-450L	1/4HP	7.69DISP
RFN091	AQAW91X	400-525L	1/4+HP	9.1 DISP
RFN110	AQAW110X	530-630L	1/3+HP	10.86DISP



FF112HBKW	1/3HP	10.61DISP	R134A	LBP
FG95HAK	1/3HP	10.61DISP	R134A	LBP
FGS130HAW	1/4HP	7.15DISP	R134A	LBP
FGS80HA	1/4HP	7.15DISP	R134A	LBP



RFAC25	59W	2.5DISP		
RFAS30	58W	3.0DISP		
RFAS35	72W 240V	3.55DISP		
RFAS43	84W	4.3DISP		



**CANT FIND WHAT YOUR LOOKING FOR! CALL US ON 02 97925988 AND WE WILL ORDER IT OR BUILD ITEM FOR YOU!**

### START UP KIT FOR COMPRESSORS

PART NO.	HP	POWER	START CAP SIZE	RUN CAP SIZE	PICKUP VOLT-AGE (VAC)	DROP OUT VOLTAGE (VAC)	RELAY FLA	RES
SKC075	3/4HP	220V-240V	23MF 330V	10UF 440V	162-175	40-90	16A 277V 50HZ	35A 277V 50HZ
SKC100	1HP	220V-240V	72-88MF 330V	15UF 440V	162-175	40-90	16A 277V 50HZ	35A 277V 50HZ
SK150	1 1/2HP	220V-240V	72-88MF 330V	20UF 440V	186-215	40-90	16A 277V 50HZ	35A 277V 50HZ
SK200	2HP	220V-240V	72-88MF 330V	25UF 330V	186-215	40-90	16A 277V 50HZ	35A 277V 50HZ
SK250	2HP	220V-240V	72-88MF 330V	50UF 330V	186-215	40-90	16A 277V 50HZ	35A 277V 50HZ

## COMPRESSORS: COMMERCIAL

### EMBRACO R134A MED TEMP

SEC/NE6160Z	1/5HP	8DISP	505W@-5
SEC/NE6170Z	1/4HP	8.78DISP	565@-5
SEC/NE6187Z	1/3HP	12DISP	735@-5
SEC/NE6210Z	1/3HP	13.6DISP	745@-5
SEC/T6213Z	3/8HP	17.4DISP	980@-5
SEC/T6215Z	1/2HP	20.4DISP	1165@-5
SEC/T6217Z	3/4HP	22.4DISP	1160@-5
SEC/NJ6220Z	3/4HP	26.2DISP	1635@-5
SEC/NJ6226Z	1HP	34.4DISP	2225@-5

### EMBRACO R404A LOW TEMP

SEC/NE2125GK	1/3HP	8.9DISP	390@-23.3
SEC/NE2134GK	1/2HP	12DISP	560@-23.3
SEC/T2155GK	5/8HP	14.5DISP	650@-23.3
SEC/T2168GK	3/4HP	17.4DISP	830@-23.3
SEC/T2178GK	1HP	20.4DISP	980@-23.3
SEC/T2180GK	1.12HP	22.4DISP	1061@-23.3
SEC/NJ2192GK	1.25HP	26.2DISP	1280@-23.3
SEC/NJ2212GK	1.5HP	34.4DISP	1640@-23.3

### EMBRACO R404A/R22 MED TEMP

SEC/NEK6165GK	1/4HP	6DISP	625@-5
SEC/NE6181GK	1/4HP	7.4DISP	755@-5
SEC/NE6210GK	1/3HP	8.9DISP	915@-5
SEC/NE9213GK	3/8HP	12DISP	1270@-5
SEC/T6217GK	1/2HP	14.5DISP	1500@-5
SEC/T6220GK	5/8HP	17.4DISP	1800@-5
SEC/T6222GK	1HP	20.4DISP	1318@-5
SEC/NJ9226GK	3/4 HP	21.7DISP	2410@-5
SEC/NJ9232GK	1.25HP	26.1DISP	2960@-5
SEC/NJ9238GK	1.5HP	32.7DISP	3960@-5



### EMERSON/COPELAND COMPRESSORS

SEC/KCN418	1/2HP	9DISP	470W@-25
SEC/KCN422	1/2HP	11.10DISP	588W@-25
SEC/KCJ423	1/2HP	32.61DISP	1635W@-5
SEC/KCE432	1/4HP	9.42DISP	565W@-5
SEC/KCE444	1/3HP	12DISP	735W@-5
SEC/KCN463	3/8HP	17.40DISP	980W@-5
SEC/KCM475	1 1/2HP	34.4DISP	1640@23.3

N.B All models 220-240V/1/50Hz supplied complete with electrics. Standard connections are stub suction & discharge except NJ compressors (CSR and CSIR type) which come complete with rotolock suction & stub discharge.

**STAREAST/EMBRACO R404A MED TEMP**

SEC/NJ9226GKSE	3/4 HP	21.7DISP	2410@-5
SEC/NJ9232GKSE	1.25HP	26.1DISP	2960@-5
SEC/NJ9238GKSE	1.5HP	32.7DISP	3960@-5
SEC/NJ2192GK	1.25HP	26.2DISP	1280@-23.3
SEC/NJ2212GK	1.5HP	34.4DISP	1640@-23.3

N.B Stub connections only.

**TECUMSEH R134A MED TEMP**

SEC/AEZ4430Y	1/4HP	8.85DISP
SEC/CAE4440Y	3/8HP	12.05DISP
SEC/CAE4448Y	1/3HP	14.15DISP
SEC/CAE4456Y	7/16HP	16DISP
SEC/CAJ4452Y	5/16HP	15.2DISP
SEC/CAJ4461Y	1/2HP	18DISP
SEC/CAJ4476Y	5/8HP	21.75DISP
SEC/CAJ4592Y	3/4HP	25.95DISP
SEC/CAJ4511Y	1HP	32.7DISP
SEC/FH4518Y	1 1/2HP	53.2DISP

**TECUMSEH R404A MED TEMP**

SEC/AEZ4440Z	1/3HP	7.55DISP	
SEC/CAE9450Z	3/8HP	9.4DISP	
SEC/CAE9470Z	1/2HP	13.3DISP	
SEC/CAE9480Z	5/8HP	15.2DISP	
SEC/CAJ9510Z	1HP	18.3DISP	
SEC/CAJ9513Z	1 1/8HP	24.2DISP	
SEC/CAJ4517Z	1 1/4HP	25.95DISP	
SEC/CAJ4519Z	1 1/2HP	34.45DISP	
SEC/FH4524Z	2HP	43.5DISP	
SEC/FH4531Z	2 1/2HP	56.65DISP	
SEC/TFH4540Z	3HP	74.25DISP	
SEC/TAG4561Z	5HP	112.5DISP	
SEC/TAJ4519Z	1 1/2HP	34.45DISP	3 PHASE

**TECUMSEH R404A LOW TEMP**

SEC/CAE2417Z	1/3HP	11.3DISP	
SEC/CAJ2428Z	1/2HP	15.2DISP	
SEC/CAJ2432Z	5/8HP	18.3DISP	
SEC/CAJ2446Z	3/4HP	26.15DISP	
SEC/FH2480Z	2HP	53.2DISP	
SEC/FH2511Z	2 1/2HP	74.25DISP	
SEC/TFH2511Z	2 1/2HP	74.25DISP	3 PHASE

**COMPRESSORS: 12-24V DC**



BD35F	DANFOSS 12/24V	2DISP	DC MOTOR
BD50F	DANFOSS 12/24V	2.5DISP	DC MOTOR
DC25	SEI ACV25DC 12/24V	2.5DISP	DC MOTOR



DC20SPARE COMPRESSOR BOARD ONLY ACV20DC 12/24V DC

**COMPRESSOR TRAYS**



RF078 PAN EVAPORATOR HAT FOR COMPRESSOR

**BOTTOM FEET COMPRESSOR PLATES**



RF099 ADAPTOR UNIVERSAL FLAT



RF099A ADAPTOR UNIVERSAL 1 CURVE

**PAN HEATERS**



RF405 CONDENSATE REMOVER, LONG  
RF405A CONDENSATE REMOVER GENUINE CRH-6960



RF406 PAN HEATER LARGE SQUARE



RF078A COMPRESSOR COVER EVAPORATION WHITE  
RF078B COMPRESSOR COVER EVAPORATION BLACK



RF078C COMPRESSOR COVER EVAPORATION



## CONDENSING UNITS



### EMBRACO R134A MED/HIGH TEMP

SEI/UNB6144Z	1/5HP	383@-5
SEI/UNE6170Z	1/4HP	509@-5
SEI/UNE6187Z	1/3HP	714@-5
SEI/UNE6210Z	1/3HP	946@-5
SEI/UT6213Z	3/8HP	946@-5
SEI/UT6215Z	1/4HP	1073@-5
SEI/UJ6220Z	3/4HP	1455@-5
SEI/UJ6226Z	1HP	1936@-5

### EMBRACO R404A LOW TEMP

SEI/UT2155GK	5/8HP	571@-25
SEI/UT2168GK	3/4HP	726@-25
SEI/UT2178GK	1HP	901@-25
SEI/UJ2192GK	1 ¼ HP	951@-25
SEI/UJ2212GK	1 ½ HP	1407@-25

### EMBRACO R404A MED TEMP

SEI/UNE6181GK	1/4HP	695@-5
SEI/UNE6210GK	1/3HP	748@-5
SEI/UNE9213GK	3/8HP	1052@-5
SEI/UT6217GK	1/2HP	1299@-5
SEI/UT6220GK	5/8HP	1547@-5
SEI/UJ9226GK	3/4HP	1992@-5
SEI/UJ9232GK	1 ¼HP	2426@-5
SEI/UJ9238GK	1 ½HP	3004@-5

## CABINET COOLERS: PATTON



### MED TEMP

SM03	310W@6KTD	R404A	SINGLE FAN
SM04	450W@6KTD	R404A	SINGLE FAN
SM06	665W@6KTD	R404A	DOUBLE FAN
SM08	825W@6KTD	R404A	DOUBLE FAN
SM10	1110W@6KTD	R404A	TRIPLE FAN
SM12	1295W@6KTD	R404A	TRIPLE FAN
SM14	1470W@6KTD	R404A	TRIPLE FAN
SM16	1645W@6KTD	R404A	TRIPLE FAN

### LOW TEMP

SL025	260W@6KTD	R404A	SINGLE FAN
SL045	435W@6KTD	R404A	DOUBLE FAN
SL050	520W@6KTD	R404A	DOUBLE FAN
SL070	695W@6KTD	R404A	TRIPLE FAN
SL080	810W@6KTD	R404A	TRIPLE FAN
SL105	1050W@6KTD	R404A	TRIPLE FAN
SL120	1200W@6KTD	R404A	TRIPLE FAN

## TECUMSEH R134A MED TEMP

SE/AEZ4430YHR	1/4HP	530@-5
SE/CAEZ4440YHR	3/8HP	685@-5
SE/CAEZ4456YHR	1/2HP	944@-5
SE/CAJZ4461YHR	1/2HP	1082@-5
SE/CAJZ4476YHR	5/8HP	1267@-5
SE/CAJZ4492YHR	3/4HP	1555@-5
SE/CAJZ4511YHR	1HP	2061@-5
SE/FH4518YHR	1 1/2HP	3050@-5
SE/FH4525YHR	2HP	4000@-5
SE/TAG4534YHR	2 3/4HP	5115@-5
SE/TAG4537YHR	3 1/3HP	5586@-5
SE/TAG4543YHR	4HP	6249@-5

## TECUMSEH R404A MED TEMP

SEI/AEZ9940Z	1/3HP	715@-5
SEI/AEZ9450Z	3/8HP	898@-5
SEI/CAE9470Z	1/2HP	1061@-5
SEI/CAJ9480Z	5/8HP	1523@-5
SEI/CAJ9510Z	1HP	1781@-5
SEI/CAJ9513Z	1 1/8HP	2336@-5
SEI/CAJ4517Z	1 1/4HP	2719@-5
SEI/CAJ4519Z	1 1/2HP	3532@-5
SEI/FH4524Z	2HP	4012@-5
SEI/FH4532Z	2 1/2HP	5462@-5
SEI/TFH4540Z	3HP	6571@-5
SEI/TAG4546Z	4HP	6352@-5
SEI/TAG4561Z	5HP	8691@-5
SEI/TAG4573Z	6 1/2HP	11205@-5

## TECUMSEH R404A LOW TEMP

SEI/CAE2424Z	1/3HP	755@-23.5
SEI/CAE2428Z	5/8HP	725@-23.5
SEI/CAE2432Z	3/4HP	840W@-23.5
SEI/CAE2446Z	1HP	1119@-23.5
SEI/CAE2464Z	1 1/2HP	1609@-23.5
SEI/FH2480Z	2HP	2432@-23.5
SEI/FH2511Z	3HP	3274@-23.5

## CONDENSORS



RF940	CONDENSOR TO SUIT WATER COOLER MINI
RF941	MINI CONDENSOR FOR MARINE APPLICATION

3600WCOND	CONDENSOR WITH AXIAL FAN
5500WCOND	CONDENSOR WITH AXIAL FAN
6600WCOND	CONDENSOR WITH AXIAL FAN

RATINGS BASED ON 32AMB TEMP



**TX VALVES  
DANFOSS**



RF358	R22 INT EQUAL
RF359	R134A INT EQUAL
RF360	R404/R507 INT EQUAL
RF361	R22 EXT EQUAL
RF362	R134A EXT EQUAL
RF363	R404A/R507 EXT EQUAL
RF363MOP	R404/R507 MOP EXT FLARE
RF363AMOP	R404/R505 MOP INT FLARE
RF363BMOP	R404A/R507 MOP EXT SOLDER
RF363C	R404/R505 EXT SOLDER
RF363D	R22 INT SOLDER
RF363E	R22 EXT SOLDER
RF363F	R404 INT SOLDER
RF363G	R134A EXT SOLDER
RF363H	R134A INT SOLDER

**ORIFICES**



RF367	T2/TE2 #0X
RF368	T2/TE2 #00
RF369	T2/TE2 #01
RF370	T2/TE2 #02
RF371	T2/TE2 #03
RF420	T2/TE2 #04
RF420A	T2/TE2 #05
RF420B	T2/TE2 #06

**MOUNTING BRACKET**



RF098	CONTROL ANGLE BRACKET
RAN31696-1	ANGLE MOUNT BRACKET
RAN48129-3	FLAT MOUNT BRACKET



CT-900M CAP TUBE FLARE NUTS 1/4 TUBE 1/8 90CM FOR LP AND HP

**H.P./L.P CONTROLS, HAND & SOLENOID VALVES**

**LOW PRESSURE CONTROLS**



016-8706 SPDT -30 TO 700 KPA RANCO 1/4" MFL

**TEMPERATURE CONTROL**



016-6951 SPDT -18 to +13 (SMALL COILED BULB) RANCO

**DUAL PRESSURE CONTROL**



017-8701 SPDT -30 TO 700 LP & 700-3000 HP RANCO 1/4" MFL

017-H4705 SPDT MANUAL RESET RANCO

**REFRIGERATION OILS**



RFRL22CF1	RL22CF POE OIL 0.9L
RFRL22H4	RL22CF POE OIL 3.8L
RFRL32H1	RL32H POE OIL 0.9L
RFRL32H4	RL32H POE OIL 3.8L
RFRL32H19	RL32H POE OIL 19L
RFRL32M1	RL32-3MAF POE OIL 0.9L
RFRL32M4	RL32-3MAF POE OIL 3.8L
RFRL32M19	RL32-3MAF POE OIL 19L
RFRL46H4	RL46H POE OIL 3.8L
RFRL46H19	RL46H POE OIL 19L
RFRL68H1	RL68H POE OIL 0.9L
RFRL68H4	RL68H POE OIL 3.8L
RFRL68H19	RL68H POE OIL 19L
RFRL100H1	RL100H POE OIL 0.9L
RFRL100H4	RL100H POE OIL 3.8L
RFRL170H4	RL170H POE OIL 3.8L
RFRL220H4	RL220H POE OIL 3.8L

**ROTALOCK STUB ADAPTOR**

ACR4080812	1/2"ID X 3/4"R/L SPUD ADAPTOR
ACR4080816	1/2"ID X 1"R/L SPUD ADAPTOR
ACR4081216	3/4"ID X 1"R/L SPUD ADAPTOR
ACR4081420	7/8"ID X 1 1/4"R/L SPUD ADAPTOR
ACR4081828	1 1/8"ID X 1 1/4"R/L SPUD ADAPTOR
ACR4082228	1 3/8"ID X 1 3/4"R/L SPUD ADAPTOR
ACR4082236	1 3/8"ID X 2 1/4"R/L SPUD ADAPTOR



RF524	SOLENOID W/ COIL ODF 1/4" 240V
RF525	SOLENOID W/ COIL ODF 3/8" 240V
RF526	SOLENOID W/ COIL ODF 1/2" 240V



RF221	1/4" LIQUID VALVE FLARE 240V COIL INCL.
RF220	3/8" LIQUID VALVE FLARE 240V COIL INCL.
RF517	THERM CONTROL MAN 5-15 DIFF 0-- -30 , 240V
RF518	THERM CONTROL MAN 5-15 DIFF -15 TO 15 , 240V
RF519	PRESSURE CONTROL -0.5~6BAR
RF520	PRESSURE CONTROL -0.5~6 BAR
RF521	DUAL PRESSURE CONTROL 5~30 BAR -0.5~6
RF522	DUAL PRESSURE CONTROL 5~30 BAR FIXED -0.5~6
RF523	DIFFERENTIAL PRESSURE CONTROL 1 BAR 60 SE



RF723A	SERVICE VALVE 7/8 SOLDER
RF724B	SERVICE VALVE 3/8 SOLDER
RF722	SERVICE VALVE 1/2 SOLDER

## CASTEL



RF792	1/4" FLARE 1020/2 240V COIL & JUNCTION BOX INCL.
RF794	3/8" FLARE 1064/3 240V COIL & JUNCTION BOX INCL.
RF795A	1/2" SOLDER BODY AND COIL
RF793	1/4" SOLDER 1028/2 240V COIL & JUNCTION BOX INCL.
RF795	3/8" SOLDER 1068/3 240V COIL & JUNCTION BOX INCL.

## HAND VALVES



RF160	1/4" WITH FLARES
RF160I	1/4" WITH FLARES ITALIAN
RF161	3/8" WITH FLARES
RF161I	3/8" WITH FLARES ITALIAN
RF160A	1/2" WITH FLARES

## LINE VALVES



RF2000	1/4" FLARE
RF2001	3/8" FLARE
RF2002	1/2" FLARE
RF2003	5/8" FLARE
RF2004	1/4" SOLDER
RF2005	3/8" SOLDER
RF2006	1/2" SOLDER
RF2007	5/8" SOLDER

## CAP VALVES



RF2008	1/4" FLARE
RF2009	3/8" FLARE
RF2010	1/2" FLARE
RF2011	5/8" FLARE
RF2012	1/4" SOLDER
RF2013	3/8" SOLDER
RF2014	1/2" SOLDER
RF2015	1/4" SOL X 1/4" FLARE
RF2016	3/8" SOL X 3/8" FLARE

## BALL VALVES (WITH ACCESS)



RF2017	1/4"
RF2018	3/8"
RF2019	1/2"
RF2020	5/8"
RF2021	3/4"
RF2022	7/8"
RF2023	1 1/8"
RF2024	1 3/8"
RF2025	1 5/8"
RF2026	2 1/8"
RF2027	2 5/8"
RF2028	3 1/8"
RF2029	2 5/8" F/F
RF2030	3 1/8" F/F

## BALL VALVE ACTUATOR



RF2031	SUIT 1 1/8" & 1 3/8" VALVES
EF2032	SUIT 1 5/8" VALVES
RF2033	SUIT 2 5/8" STD VALVES
RF2034	SUIT 2 5/8" F/F VALVES

## MUELLER CHECK VALVES



RF2035	1 1/8" ID MAGNETIC
RF2036	1 3/8" ID MAGNETIC
RF2037	1 5/8" ID MAGNETIC
RF2038	2 1/8" ID MAGNETIC
RF2039	1/4" ID W/ TAILS
RF2040	3/8" ID W/ TAILS
RF2041	1/2" ID W/ TAILS
RF2042	5/8" ID W/ TAILS
RF2043	7/8" ID SCREW BONNET

## MUELLER CHECK VALVES



RF2044	7/8" ID 4 BOLT
RF2045	1 1/8" ID 4 BOLT
RF2046	1 3/8" ID 4 BOLT
RF2047	1 5/8" ID 4 BOLT
RF2048	2 1/8" ID 4 BOLT
RF2049	2 5/8" ID 4 BOLT

## PRESSURE RELIEF VALVES



RF2050	3/8" MNPT 1620kPa
RF2051	3/8" MNPT 2070kPa
RF2053	3/8" MNPT 2410kPa
RF2054	3/8" MNPT 2760kPa
RF2055	3/8" MNPT 2930kPa
RF2056	3/8" MNPT 3100kPa
RF2057	1/2" MNPT 1620kPa
RF2058	1/2" MNPT 2070kPa
RF2059	1/2" MNPT 2410kPa
RF2060	1/2" MNPT 2760kPa
RF2061	1/2" MNPT 2930kPa
RF2062	1/2" MNPT 3100kPa
RF2063	3/4" MNPT 1310kPa
RF2064	3/4" MNPT 1620kPa
RF2065	3/4" MNPT 2070kPa
RF2066	3/4" MNPT 2760kPa
RF2067	3/4" MNPT 2930kPa
RF2068	3/4" MNPT 3100kPa

RF2069	1"NPTF 1310kPa
RF2070	1"NPTF 1620kPa
RF2071	1"NPTF 2070kPa
RF2072	1"NPTF 2410kPa
RF2073	1"NPTF 2760kPa
RF2074	1"NPTF 2930kPa
RF2075	1"NPTF 3100kPa

**MANIFOLD & RUPTURE DISCS**



RF2076	1/2" RELIEFMASTER MANIFOLD
RF2077	3/4" RELIEFMASTER MANIFOLD
RF2078	1" RELIEFMASTER MANIFOLD
RF2079	1/2" @ 2760kPa DISC
RF2080	1/2" @ 2930kPa DISC
RF2081	4PSI OPEN-ON-FALL SWITCH
RF2082	GAUGE RUPTURE DISC

**ROTALOCK VALVES**



RF2083	3/8" ID X 3/4" NUT
RF2084	3/8" ID X 1" NUT
RF2085	1/2" ID X 3/4" NUT
RF2086	1/2" ID X 1" NUT
RF2087	5/8" ID X 1" NUT
RF2088	5/8" ID X 1 1/4" NUT
RF2089	3/4" ID X 1 1/4" NUT
RF2090	7/8" ID X 1 1/4" NUT
RF2091	7/8" ID X 1 3/4" NUT
RF2092	1 1/8" ID X 1 1/4" NUT
RF2093	1 1/8" ID X 1 3/4" NUT
RF2094	1 3/8" ID X 1 3/4" NUT
RF2095	1 5/8" ID X 1 3/4" NUT
RF2096	1 5/8" ID X 2 1/4" NUT



RF218	SOLENOID SERVICE MAGNET
-------	-------------------------

**FILTER DRYERS**  
**ITALIAN**



PLY-052/MG112	1/4" SAE
PLY-053/MG122	3/8" SAE
PLY-082/MG213	1/4" SAE
PLY-083/MG223	3/8" SAE



PLY-305AP	5/8" WITH SCHRADER VALVE
-----------	--------------------------



PLY-SCM052	1/4" SAE SIGHT GLASS COMB SCMI052MM
PLY-SCM083	3/8" SAE SIGHT GLASS COMB SCMI083MM



PLY-052	1/4" FLARE
PLY-052S	1/4" SOLDER
PLY-082	1/4" FLARE
PLY-083	3/8" FLARE
PLY-083S	3/8" SOLDER
PLY-164	1/2" FLARE
PLY-165	5/8" FLARE
PLY-162A	1/4" FLARE LARGE BODY



PLY-163AP	3/8" WITH SCHRADER VALVE
PLY-164AP	1/2" WITH SCHRADER VALVE
PLY-165AP	5/8" WITH SCHRADER VALVE

**JUMBO (10" LENGTH)**

JD-083	3/8" JUMBO (10") FLARE
JD-085	5/8" JUMBO FLARE

**SIGHT GLASSES**



RF364	1/4" MALE TO MALE
RF364A	1/4" MALE TO FEMALE
RF365	3/8" MALE TO MALE
RF365A	3/8" MALE TO FEMALE
RF366	1/2" MALE TO MALE
RF193	1/4" SIGHT GLASS SOLDER TYPE
RF194	3/8" SIGHT GLASS SOLDER TYPE
RF530	SIGHT GLASS ODF 5/8 MAX PRESSURE 35BAR



AVA826	1.1/8" ROTOLOCK VALVE
AVA827	1.1/8" ROTOLOCK, 7/8 PIPE
AVA828	1.1/8" ROTOLOCK VALVE, 7/8 PIPE
AVA829	1.1/8" ROTOLOCK VALVE, 1.1/8 PIPE
RF366	1/2" MALE TO MALE

ACR40012	ROTALOCK GASKETS
----------	------------------

## PRESSURE REGULATORS

### EVAPORATOR



KVP12	1/2" FLARE
KVP15	5/8" FLARE
KVP12S	1/2" SOLDER
KVP15S	5/8" SOLDER
KVP22S	7/8" SOLDER

### CRANKCASE



KVL15S	5/8" SOLDER
KVL22S	7/8" SOLDER
KVL28S	1 1/8" SOLDER
KVL35S	1 3/8" SOLDER

## SCHRADER VALVES & FILTER DRIERS (ALL GASES)

### SCHRADER VALVES



RF023	1/4" 95MM
RF023L	1/4" 90MM
RF023S	1/4" 60MM
RF024	3/16" 65MM
RF024A	3/16" W/CORE REMOVER SMALL PIPE
RF023CAP	SCHRADER CAP (PKT 5)



RF2083	SCHRADER CORE R410A
RF2084	SCHRADER CAP & O RING R410A
RF2085	SCHRADER CAP W/ TOOL 1/4"

## DRIERS WITH TAIL



RF022	10-13 GRAMS
RF025	15 GRAMS
RF026	20 GRAMS 1/4"
RF026A	25 GRAMS 1/4"



RF148	HIGH CAPACITY 20G DIRENAL SERVICE
RF149	HIGH CAPACITY 20G WITH SCHRADER VALVE END

## DRIERS



RF140	10 GRAMS
RF141	15 GRAMS
RF142	20 GRAMS
RF143	25 GRAMS

## OIL SEPARATORS



ACR30706	3/8 OD 100D X 247LG
ACR30708	1/2 OD 100D X 247LG
ACR30710	5/8 OD 100D X 300LG
ACR30714	7/8 OD 100D X 344LG
ACR30718	1 1/8" OD 100D X 370LG
ACR30722	1 3/8" OD 152D X 352LG
ACR30726	1 5/8" OD 152D X 429LG

## MUFFLERS & SUCTION ACCUMULATORS

### DISCHARGE MUFFLERS



ACR31114	7/8"
ACR31118	1 1/8"
ACR31122	1 3/8"
ACR31126	1 5/8"
ACR31132	2 1/8"

### VIBRATION ELIMINATOR



VPVAF3	3/8"
VPVAF4	1/2"
VPVAF5	5/8"
VPVAF6	3/4"
VPVAF7	3/4"
VPVAF8	7/8"
VPVAF9	1 1/8"
VPVAF10	1 3/8"
VPVAF11	1 5/8"
VPVAF82	2 1/8"
VPVAF83	2 5/8"

## SUCTION ACCUMULATORS



ACR3061016	5/8" 102DIA X 218LG X 1.6L
ACR3061019	5/8" 102DIA X 270LG X 1.9L
ACR3061216	3/4" 102DIA X 244LG X 1.6L
ACR3061226	3/4" 128DIA X 255LG X 2.6L
ACR3061434	7/8" 128DIA X 325LG X 2.6L
ACR3061440	7/8" 128DIA X 370LG X 4.0L
ACR3061855	1 1/8" 159DIA X 390LG X 5.5L
ACR3061859	1 1/8" 140DIA X 430LG X 5.9L
ACR3062263	1 3/8" 160DIA X 350LG X 6.3L
ACR3062271	1 3/8" 159DIA X 460LG X 7.2L
ACR3062610	1 5/8" 160DIA X 575LG X 10.5L
ACR3063415	2 1/8" 219DIA X 368LG X 15L



**FANS & GRILL (SINGLE & THREE PHASE)**



FP-108-1	AC AXIAL FAN 120*120*38 240V 0.125/0.10A
FP-108-24V	DC AXIAL FAN 120*120*38 24V
FP-108A	AC AXIAL FAN 80*80*38 16.25/13.2W 240V
FP-108A/DC	DC B/L AXIAL FAN 90*90*25 12V 0.08A
FP-108AX	AC AXIAL FAN 80*80*25 13/14W 0.12/0.10A
FP-108B/DC	DC B/L AXIAL FAN 90*90*25 24V 0.18A
FP-108F/DC	DC B/L AXIAL FAN 60*60*25 12V-S1 0.13A
FP-108X	AC AXIAL FAN 120*120*25 240V 0.12/0.11A
TFB-1088	DC AXIAL FAN 92*92*25 12V



FP-108C	AC AXIAL FAN 170*150*55 240V 46/40W
FP-108CX	AXIAL FAN 240V 0.18/0.16A 27/24W COMMON



FP-108EX	AC AXIAL FAN 150*170*50 240V 0.29A 35W
----------	--



YX2540	DC AXIAL FAN 80*80*25 WITH SLEEVE
--------	-----------------------------------

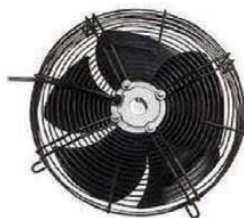

**SINGLE PHASE**

RF401A	200MM AXIAL FAN WITH GRILL & MOTOR
RF401B	250MM AXIAL FAN WITH GRILL & MOTOR
RF401	300MM AXIAL FAN WITH GRILL & MOTOR
RF402	350MM AXIAL FAN WITH GRILL & MOTOR
RF403	400MM AXIAL FAN WITH GRILL & MOTOR
RF402A	450MM AXIAL FAN WITH GRILL & MOTOR
RF403A	500MM AXIAL FAN WITH GRILL & MOTOR
RF403B	550MM AXIAL FAN WITH GRILL & MOTOR
RF403C	600MM AXIAL FAN WITH GRILL & MOTOR

**THREE PHASE**

RF901	300MM 3-PHASE AXIAL FAN WITH GRILL SUCTION
RF902	350MM 3-PHASE AXIAL FAN WITH GRILL SUCTION
RF903	400MM 3-PHASE AXIAL FAN WITH GRILL SUCTION
RF904	450MM 3-PHASE AXIAL FAN WITH GRILL SUCTION
RF905	500MM 3-PHASE AXIAL FAN WITH GRILL SUCTION
RF906	550MM 3-PHASE AXIAL FAN WITH GRILL SUCTION
RF906	600MM 3-PHASE AXIAL FAN WITH GRILL SUCTION



PS4160	LEAD FAN 240V PLG&B FOR AXIAL FAN
--------	-----------------------------------



YX2511	GRILLE FAN 80MM
YX2515	GRILLE FAN 120MM
YX2525	GRILLE FAN 150MM

**FAN BLADES ALUMINIUM**



RF070	CW 125MM
RF070B	195MM
RF070C	CW LARGER TYPE 235 - 300MM
RF070D	100/3.2 4PL NUT & CLIP
RF070E	200MM 22°
RF070F	200MM 28°
RF070G	200MM 34°
RF070J	230MM 28°
RF045	CW 100MM

**PLASTIC**



RF070A	80MM - 100MM
--------	--------------



RF070H	130MM
--------	-------



RF070I	95MM
--------	------

**AXIOM SERVICE FAN BLADES**



RF070M	SMALL TO MEDIUM ADJUSTABLE FAN BLADE 150-305MM
RF070L	MEDIUM TO LARGE ADJUSTABLE FAN BLADE 405-660MM

**PRESSURE REGULATORS, MUFFLERS, VIBRATION, AXIAL FANS**



## DIGITAL THERMOMETERS, TIMERS & CONTROLS THERMOMETERS



**DT-1001C** ELECTRONIC WALL MOUNT (WHITE)



**DT-1001S** SOLAR POWERED THERMOMETER



**DT-101S** DIGITAL THERMOMETER



**DT-2001SC** SOLAR POWERED ROUND & SENSOR PROBE



**EG9739** 0 TO 120°C 55MM DIAL  
**EF621387** 0 TO 300°C 55MM DIAL



**MT-73** -40 TO +40°C WITH BACK BRACKET



**PLS-020A** AUTO REFRIGERATOR CONTROL UNIT



**QM7209** FRIDGE/FREEZER MINI



**TMRB-040-32B** -40 TO +40°C  
**TMRB-120-32B** 0 TO 120°C



**TMRC-040-33H** COOLROOM -40 TO +40°C  
**TMRC-120-33H** COOLROOM 0 TO 120°C



**TMSA-040-32B** -40 TO +40°C LONG SMALL



**TIM14149** 0-120°C IMIT



**TMT100** -40 TO +20°C 2" PRESSURE



**TMT3PC** COOLROOM -40 TO +40°C



**TMT53** S/S SQUARE & HOOK -30°C TO +30°C & °F



**TMT55** ROUND ON STAND & HOOK -30°C TO +30°C & °F



**TMT77** FREEZER/FRIDGE + STAND -30°C TO +30°C & °F

**TMS23** ROUND PLASTIC & HOOK -30 TO +50°C (NO F)

**TMS23A** PLASTIC WITH HOOK ADJUSTABLE



**TM-180** NON-CONTACT LASER



**EVCO THERMOMETER CONTROLS**



<b>EVK 100M7</b>	DIGITAL THERMOMETER KIT
<b>EVK 100P7</b>	240V,Digital Display Only PTC, NTC -50 TO +150°C
<b>EVK401P7</b>	240V, Single out/put PTC, NTC -50 TO +150°C
<b>EVK411P3</b>	12/24V, Single out/put PTC, NTC -50 TO +150°C
<b>EVK411M7VHBS</b>	240v,single out/put, Multi probe In/put PTC,NTC,'J','K';PT100,PT1000,0- 10v,4-20mA
<b>EVK412P7</b>	240V, two out/putS, PTC, NTC -50 TO +150°C
<b>EV6421P7VHBS</b>	240v, single out/put, Din Rail Mount PTC, NTC -50 TO +150°C
<b>EV6421P3VHBS</b>	240v, single out/put, Din Rail Mount PTC, NTC -50 TO + 150°C
<b>EV7402M6</b>	240v,two out/puts, Multi Probe in/put, 72x72 PTC,NTC,'J','K';PT100,PT1000,0- 10v,4-20mA

**EVCO HUMIDITY CONTROLS**

<b>EVK50017</b>	240V DISPLAY ONLY 4-20MA
<b>EVK52117VHBS</b>	240V SINGLE OUTPUT 4-20MA

**SENSORS / THERMOCOUPLES/ACCESS**

<b>ECSND5910G</b>	1.5m PVC NTC probe
<b>ECSND0112A</b>	1.5m Silicon PTC probe
<b>ECSND1413A</b>	1.5m, braided, PT100, RTD sensor
<b>ECSND1243A</b>	3m, Silicon, PT100, RTD Sensor
<b>ECSND3343A</b>	3m, Braided, PT100, RTD Sensor
<b>ECSND9X10G</b>	1.5m, Thermoplastic, PT1000 Sensor
<b>ECSND3313A</b>	1.5m, braided, 'K' Type Thermocouple
<b>ECSND1313A</b>	1.5m, braided, 'J' Type Thermocouple
<b>EVHP/503</b>	HUMIDITY SENSOR
<b>EVHTP/503</b>	HUMIDITY / TEMPERATURE SENSOR
<b>ECSND5940G</b>	3m, NTC PVC probe
<b>ECSND0142A</b>	3m PTC probe

**EVCO REFRIGERATION CONTROLS**



<b>ASQK230000</b>	240v, 3 out/puts,Coolroom Controller Low Temp*PTC*
<b>ASQX214000</b>	240v, 4 out/ puts,RTC,Haccp,Coolroom Controller NTC/PTC
<b>ASQK231000</b>	240v, single out/put,Coolroom Controller *NTC*

**REFRIGERATION CONTROLS**

<b>EVK 201 N7</b>	240v, Single out/put, Med temp NTC/PTC
<b>EVK 201N7P</b>	MED TEMP CONTROLLER 1 PROBE WITH PLUG FITTING
<b>EVK 203 P7</b>	240v, 3 out/puts, Low temp PTC/NTC
<b>EVK203P7P</b>	LOW TEMP CONTROLLER 2 PROBE WITH PLUG
<b>EVK211P-3VXBS</b>	MED TEMP CONTROLLER 1 PROBE 12/24V
<b>EVK214N9VXBS</b>	240v, 4 out/puts, RTC, Haccp Serial port NTC/PTC
<b>EVK411J7</b>	DIGITAL THERMOSTAT -100 TO 800 DEG
<b>EVK711D7</b>	DIGITAL CONTROL COUNT/ UP/DOWN
<b>EVK211P3VXBS</b>	12/24v, Single out/put, PTC/ NTC
<b>EV6221P7VXBS</b>	240v, Single out/put, Din Rail Mount, Med Temp , PTC/NTC
<b>EV6223P7VXBS</b>	240v, 3out/puts,Din Rail Mount, Low Temp PTC/ NTC

**RACK CONTROLLERS**

<b>CPU1DOA2CXROOE</b>	12v, 4 Compressors
<b>EC67081220S001</b>	240v, 8 Compressors
<b>CPG2LOC4XXROOE</b>	24v, 12 Compressors



**ST-8001** CONTROL MOUNTING BOX  
TRANSPARENT LID



**ST-8002** CONTROL MOUNTING BOX  
XLARGE 350X250X120MM



**ST-8000B** CONTROL MOUNTING BOX FOR  
ST-8000 & ST-8000A

**ST-8000C** CONTROL MOUNTING BOX  
LARGER TYPE



**ECB-1000Q** INTELLIGENT ELECTRICAL 3HP-  
CONTROL LARGER BOX

Go to  
**stareast.com.au**  
For new product updates  
and realtime product on-  
line purchasing.

## DIGITAL THERMOMETERS, TIMERS & CONTROLS DEFROST TIMERS



TH001 THEBEN 24HR 16A 240 WITH CASE



TH002A 24H SYN 240V BLACK



RF017A SANKYO TMDE309ZC-STD



RF017B SHARP SMALL SHAPE



RF017C TMDJX25RC1 12H21M



RF017D GENUINE SUIT W'POOL/ASIAN  
RF017DD GENERIC SUIT W'POOL/ASIAN



RF017E TD20LSA 110V



RF096A PARAGON 120V



RF096BB HEAVY DUTY GENERIC



RF096BM HEAVY DUTY SAME AS RF096BB (TYPE 2)



RF096G GENERIC 6H21M METAL



RF100U UNIVERSAL 240V



RF101 TMDJ521ZC1 6H25M



RF103 DBZC-825-1 8H25M 8AMP  
RF097 GENUINE 8H20M PLASTIC



RF016B ADJUSTABLE 5A 4PIN



RF180 TIMER WITH CAM ASSEMBLY

RF180A TIMER WITH CAM ASSEMBLY GENERIC



TMDE503FC 4 WIRE 8H12M  
TMDE802GF 4 WIRE 8H10M





- RF642 DELAY ON MAKE TIMER TD-69
- RF642A DELAY ON MAKE TIMER TD-73
- RF642B DELAY ON MAKE TIMER ADM-68 .03-10MIN
- RF642C DELAY ON MAKE TIMER ADM-72
- TT3M-3S12D 12V DC 8 PIN 3S-30MIN, 6S-60MIN



RF227 EDT12 120V 25A



RF226 EDT13-20 220V 25A



ICM DELAY-ON-BREAK TIMER 10MIN 18-240VAC  
UNIVERSAL START RELAY TO 10HP 110-270VAC SINGLE PHASE

**ECONOMY MULTI-RANGE TIMER**



- TT3M-3S24 24V AC 8 PIN 3S-60MIN, 6S-30MIN
- TT3M-3S240 240V AC 8 PIN 3S-60MIN, 6S-30MIN
- TT3M-3S415 415V AC 8 PIN 3S-30MIN 6S-60MIN

**MULTI-RANGE / MULTI-FUNCTION TIMER**



- TM48S-3 24-240V AC/DC 3S-30MIN
- TM48S-3M 24-240V AC/DC 3MIN-30HRS
- TM48S-6 24-240V AC/DC 6S-60MIN
- TH3CR-A 240V AC 11 PIN
- TH3CR-A8 240V AC 8 PIN
- TH5C-11S 11 PIN DIGITAL 0.001S-9999HR 1C CONTACTS
- TH5C-11D 11 PIN DIGITAL 0.001S-9999HR 2C OR 1A1C CONTACTS



- CRM-91H 12-240V AC/DC 0.1S-10DAYS
- CRM-93H 12-240V AC/DC 0.1S-10DAYS 3 C/O CONTACTS
- EUR19M 24-240VAC 0.6S ~ 100HRS
- CRM-82TO UNI 12-240V AC/DC DELAY OFF TIMER 1S-10MIN
- SMR-T 23 0V AC FAN RUN ON TIMER
- EUR19-1 DIN RAIL TIMER, ON DELAY 0.3SEC - 30MIN 100-240V AC/DC
- EUR19-3 DIN RAIL TIMER, ON DELAY 0.1SEC - 10HRS 100-240V AC/DC
- EUR19-Y STAR DELTA TIMER 1S ~ 100SEC 240V

**TIMING RELAY BASES**



- US-08 ROUND 8 PIN BASE PANEL
- P2CF-08 ROUND 8 PIN BASE WITH CLIPS DIN
- P2CF-11 ROUND 11 PIN BASE WITH CLIPS DIN
- P3G-08 8 PIN BASE BACK WIRED SURFACE
- P3G-11 11 PIN BASE BACK WIRED SURFACE

**PANEL MOUNT ACCESSORIES**



- Y40 PANEL MOUNT TO SUIT TT3M-3S
- Y48 PANEL MOUNT TO SUIT TM-48S

**SOLID STATE TIMERS**



- ICM105 DELAY ON MAKE COMPRESSOR STARTUP DELAY TIMER
- ICM203 DELAY ON BREAK ANTI SHORT CYCLE/LOCKOUT TIMER

**CONDENSER FAN MOTORS**



- RFUC25W PROGRAMMABLE UNADA EVAP MOTOR 25W 240V
- RFUC-PROGRAM PROGRAMMER, POWER BOX, USB SET UP FOR UNADA



- RF512 SQUARE MOTOR 10W
- RF513 SQUARE MOTOR 16W
- RF515 SQUARE MOTOR 25W
- RF516 SQUARE MOTOR 34W



RF605A GENUINE BLACK 9W 220-240V COMMERCIAL





RF188 50D543-03A HUB 40W

**GENUINE**



RF601A GE/WHIRLPOOL BLACK 2W 220VAC GENUINE

**GENERIC**



RF508 10W YJ10-4-240

RF509 20W YJ20-4-240



RFA707B SQUARE MOTOR 5-7W

RFA707A SQUARE MOTOR 10W

RFA707 SQUARE MOTOR 16W

RFA942 SQUARE MOTOR 20W

RFA941 SQUARE MOTOR 25W

RFA210 SQUARE MOTOR 34W



RFAA707 10W 0.25A 1300/1550R



RF511A SQUARE MOTOR 5W

RF512A SQUARE MOTOR 10W

RF513A SQUARE MOTOR 16W

RF515A SQUARE MOTOR 25W

RF516A SQUARE MOTOR 34W

**GE**



RF601 GE/WHIRLPOOL BLACK 2W 220VAC



RF602 GE 2W 110VAC

RF603 GE 6W 240VAC

RF604 GE 6W 110VAC

RF605 GE 9W 240VAC



RFB02W 2W BLACK NEW TYPE EASY FIT

RFB09W 9W BLACK NEW TYPE EASY FIT

RFB18W 18W BLACK NEW TYPE EASY FIT

RFB20W NEW 20W BLACK MOTOR

**EVAPORATOR FAN MOTORS**



RF039-1 REVERSIBLE FROST FREE UNIVERSAL

RF039-2 REVERSIBLE FROST FREE FLAT BACK UNIVERSAL



RF039A KOREAN 220V



RF039B UNIVERSAL FOR GE 100/120V 11W 0.18A 2500RPM



RF039C GE CW PHIL SB44ASE057



RF039D REVERSIBLE 10W CW PS614-501



RF039DD REVERSIBLE 10W CW PS614-502



RF039E REVERSIBLE 10W PS609BA

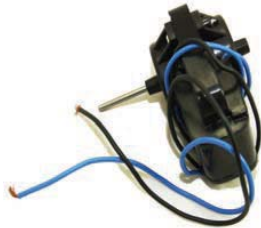

RF039ES REVERSIBLE NEW TYPE



RF039L LOW VOLTAGE 4B3YU6182



RF039V CCW SHORT, THICK SHAFT



RF039F CCW PS614A



RF039M REVERSIBLE CW 3.17SHAFT



RF039W 3 WIRE LONG, THICK SHAFT  
240VAC 3 X 6.4MM TERM OVER-  
ALL LENGTH INCL  
MOTOR 250MM



RF039G REVERSIBLE 220V RE-01WT52



RF039N 190W 607A-535



LG082 LG RDA-082E07  
ELECTRONIC



RF039H 220V 50/60HZ IS-23210

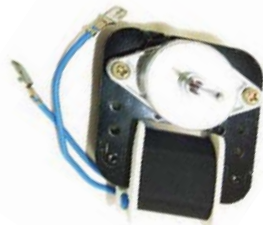

RF039S FROST FREE REVERSIBLE 240V  
0.11A 50HZ CW OR CCW 40MM  
SHAFT LENGTH



SE203 ROTARY FAN LEFT HAND SIDE  
SE204 ROTARY FAN RIGHT HAND SIDE



RF039I 0.09A 240V 2500RPM 50HZ  
10.3W, SCREWS INCLUDED



RF039T 7W 220V 50HZ



RF001B COMMERCIAL LARGE MLD 240V  
0.3A 50Hz CW OR CCW D SHAFT  
35MM LONG



RF039K INSULATED WIRING



RF039U REVERSIBLE SUITS AMANA



RF001C COMMERCIAL UNIVERSAL LARGE  
MLD



**RFSM-672A** UNIVERSAL COMMERCIAL WITH FAN



**RFSM-998** DOMESTIC UNIVERSAL KIT



**FP877730** FISHER & PAYKEL 220V 8W 50HZ FITTED WITH 4.8MM SPADE TERMINALS 34MM SHAFT (LONG)

**FP877730A** FISHER & PAYKEL 220V 8W 50HZ FITTED WITH 4.8MM SPADE TERMINALS 15MM SHAFT (SHORT)



**RF505** COMMERCIAL 30W BOTTLE



**RF506** WITH FAN COMMERCIAL 27W 0.2A



**FP881113** F&P FAN KIT FC 12V DC SMALL SIZE

**FP883341** F&P FAN KIT FC 12V DC LARGE SIZE

## BULLET VALVES



**RF001** BPV21 PIERCING 1/2; 5/8

**RF002** BPV31 SUPCO 1/4; 5/16; 3/8

**RF002A** PIERCING TWO SCREWS



**RF002B** ADJUSTABLE LINE TAP VALVE 1/4 - 3/8"

## RELAYS & OVERLOADS

### RELAYS



**RFR220** 1/3 RELAY + OVERLOAD

**RFR221** 1/4 RELAY + OVERLOAD

**RFR222** 1/5 RELAY + OVERLOAD

**RFR223** 1/6 RELAY + OVERLOAD



**RF011** UNIVERSAL RELAY FITS 1/12A TO 1/2 HP.220



**RF012** RELAY UNIVERSAL 1/12 TO 1/2 HP WHITE

**RF013** RELAY UNIVERSAL 1/12 TO 1/2 HP WHITE



**RF014** RELAY OVERLOAD SUIT 1/6 - 1/5HP IG25 R062

**RF015** RELAY OVERLOAD SUIT 1/4 - 1/3HP IG23 R042

**RF015A** RELAY OVERLOAD SUIT 1/2HP R022

**RF015B** RELAY OVERLOAD SUIT 1/2 - 1/8HP

**RF132** DANFOSS RELAY SOLID STATE GENUINE (0011)



**RF132A** DANFOSS RELAY SOLID STATE GENUINE (0002)

**RF132N** START RELAY S/S GENERIC STAREAST



**RF158** PTC RELAY 4 PINS 1/4; 1/3



**RF159** 1/4; 1/3 TYPE 222KY OVERLOAD PROTECTOR





**RF222** RELAY SOCKET 8 PIN



**RF225** BACKUP RELAY 30A

**RF225A** BACKUP RELAY 692/240/A5/2C22F(551) 2 POLE

**RF225AC** BACKUP RELAY 24V AC 30A 2.5HP DPST

**RF225DC** BACKUP RELAY 12V DC 30A 2HP DPST



**RF600** SUPER START CAPACITOR 115V-250V 1/2-10HP SPP5

**RF616** RELAY & START 1/12-1/2HP 230V EASY INSTL

**RF611** SUPER BOOST RELAY 1/2-3HP SPP6E

**RF612** SUPER BOOST RELAY 1-4HP SPP7E

**RF613** SUPER BOOST RELAY 1-5HP SPP8E

**RF614** 3 WIRE HAND START KIT 1-2HP 500V

**RF615** 3 WIRE HAND START KIT 4-5HP 420V



**VSSPP** STARTER POW-R-PACK 250%

**VSSPP5** STARTER POW-R-PACK 300%

**VSSPP6** STARTER POW-R-PACK 500%



**ML012** MOTOR & LAMP CONTROLLER (DIMMER)



**RCO220** 3 IN 1 START RELAY 1/2HP 230V

**RCO420** 3 IN 1 START RELAY 1/4-1/3 HP 230V

**RCO620** 3 IN 1 START RELAY 1/6-1/5 HP 230V

**RCO820** 3 IN 1 START RELAY 1/12-1/10-1/8HP 230V

**KICKSTART™**



**RF96506** COMPRESSOR HARD START DEVICE KS-1

**RF96503** COMPRESSOR HARD START DEVIDE TO-5



**RF207** STEP DOWN COMPRESSOR RELAY ABOVE 110V 8A

**SOLID STATE RELAYS/DIMMERS**



**SR-R2510** DIMMER 10A 25-250VAC

**SR-R2525** DIMMER 25A 25-250VAC

**SR-R2540** DIMMER 40A 25-250VAC



**SRA2510N** 10A 90-240V AC

**SRD2525N** 25A 90-240V AC 3-32V DC

**SRD2540N** 40 90-240V AC 3-32V DC 62.05

**SRU2425N** 25 90-240V AC 3-32 V AC/DC 54.80

**SRU2440N** 40 90-240V AC 3-32V AC/DC 62.05

**SRA4840N** 40 90-240V AC 90-480V AC 66.35

**CONTACTORS**



**RF617** 3 POLE 208-240V CONTACTOR 35A 25FLA

**RF618** 3 POLE 208-240V CONTACTOR 40A 30FLA

**RF619** 3 POLE 208-240V CONTACTOR 50A 40FLA



**RF223** CONTACTOR, RELAY & AUXILLARY 12A 5.5KW

**RF223A** CONTACTOR GMC-12 240V

**RF224** CONTACTOR, RELAY & AUXILLARY 18A 9KW



**RF634** GMC-18 240V CONTACTOR

**RF634A** GMC-18 415V CONTACTOR

**RF635** GMC-22 240V CONTACTOR

**RF636** GMC-32 240V CONTACTOR

**RF636A** GMC-32 415V CONTACTOR

**OVERLOADS**



**RF638A** 12-18A OVERLOAD GTK-22

**RF638B** 16-22A OVERLOAD GTK-22

**RF638F** 16-22A OVERLOAD GTK-40

**RF638C** 18-26A OVERLOAD GTK-22

**RF638D** 24-36A OVERLOAD GTK-22

**RF638E** 5-8A OVERLOAD GTK-22

**RF638G** 6-9A OVERLOAD GTK-22



## OVERLOADS



RF627	AIRCON OVERLOAD 1/2HP MRA98688
RF628	AIRCON OVERLOAD 3/4HP MRA98735
RF629	AIRCON OVERLOAD 1HP MRA98766
RF630	AIRCON OVERLOAD 1.5HP MRA99120
RF631	AIRCON OVERLOAD 2HP MRA99123

## BRAZING



RF031A	ROD 2% YELLOW TIP
RF031AKG	ROD 2% YELLOW TIP BY KILO
RF031B	ROD 5% SILVER TIP
RF031BKG	ROD 5% SILVER TIP BY KILO
RF051	ROD 15% BROWN TIP
RF051KG	ROD 15% BROWN TIP BY KILO
RF031	ROD 45% BLUE/WHITE TIP
RF031KG	ROD 45% BLUE/WHITE TIP BY KILO
RF031D	BRAZING ROD COPPER TO COPPER
RF031E	ALUMINIUM WELDING ROD 71850
RF031F	2% SILPHOS ROD ROUND 3MM



RF031G	5% SILPHOS ROD SQUARE 4MM
RF031H	20% SILPHOS ROD FLUX COATED



RF032 WHITE BRAZING FLUX (COPPER, BRASS, S/S, MONEL, NICKEL ETC)



RF032A ALUMINIUM BRAZING FLUX POWDER



RF032B ALUMINIUM BRAZING FLUX KIT 1070

RF032C ALUMINIUM BRAZING FLUX KIT 500



RF052 CONNECTOR ALUMINIUM TO COPPER



RF069 EVAPORATOR RED EPOXY KIT W/ SANDPAPER



RF095 LA-CO HEAT SEAL STICK GREEN EPOXY

## CAPILLARY TUBING PACKS



RF333-0	0.60MM SP-0
RF333	0.66MM SP-1
RF334	0.80MM SP-2
RF335	0.90MM SP-3
RF336	1.10MM SP-4
RF337	1.30MM SP-5
RF338	1.40MM SP-6
RF339	1.62MM SP-7
RF340	1.78MM SP-8
RF341	1.90MM SP-9
RF342	2.04MM SP-10
RF343	2.24MM SP-11

## REFRIGERATION HEATING ELEMENTS DEFROST HEATERS



AM001 AMANA & OTHERS HEATING ELEMENT 600W



3610 DEFROST ELEMENT 250W

3741 DEFROST ELEMENT 200W PHIL/HOOVER LARGE



10314 450W DEFROST ELEMENT LENGTH 520MM

10315 500W DEFROST ELEMENT LENGTH 575MM



LG005 LG GR-T392 S352GC



RF006 MALLEYS BLACK HEATER IMMERSION 32V



RF118 DEFROST HEATER 1435487

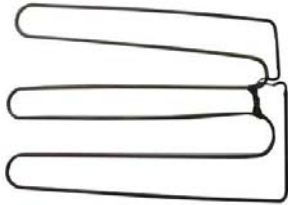

RF046 MALLEYS EVAPORATOR HEATER LARGE SHAPE



RF109A DEFROST ELEMENT STRAIGHT 300W BENDABLE



RF153 DEFROST ELEMENT 450W DOUBLE PASS



RF109 DEFROST ELEMENT 450W 525x130MM

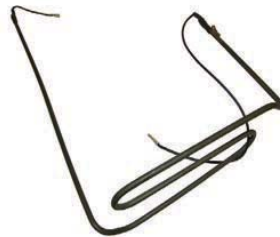

RF112 HEATER DEFROST 500W ONE SIDE LONGER

RF154 DEFROST ELEMENT 500W DOUBLE PASS

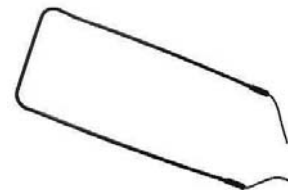

RF199 WHIRLPOOL DEFROST U BEND 250W

RF109R DEFROST ELEMENT 450W MEDIUM WITH THICK RUBBER SEAL

RF110 DEFROST ELEMENT 500W LONG 590x135MM

RF110R DEFROST ELEMENT 500W LONG WITH THICK RUBBER SEAL

RF111 DEFROST ELEMENT 350W SMALL WITH THICK RUBBER SEAL

RF111R DEFROST ELEMENT 500W LONG RUBBER

LG004 LG GR-642AP/GR-S642AQ



RF113 DEFROST HEATER KELV. HAIRPIN 350W

RF114 DEFROST HEATER KELV. HAIRPIN 475W

RF200 WHIRLPOOL DEFROST U BEND 552W

RF200A WHIRLPOOL DEFROST U BEND 614W



MY156 MAYTAG GENUINE WITH THERMO ASSY

MY156A MAYTAG GENERIC WITHOUT THERMO U SHORT

MY157A MAYTAG GENERIC U LONG



RF116 DEFROST HEATER 350W 44CM DOUBLE

RF117 DEFROST HEATER 300W 30CM DOUBLE



RF201 F&P DEFROST 266W 47CM WITH PLUG

RF202A F&P DEFROST 322W 46CM WITHOUT PLUG

RF203 F&P DEFROST 355W 57CM WITH PLUG



**SE114** DEFROST ELEMENT 500W WESTINGHOUSE (SAME AS 9684)

**DR991** 3.3M 1900 OHMS

### PVC HEATERS



**DR992** 3.67M 1925 OHMS

**DR993** 2.95M 3900 OHMS

**DR994** 3.3M 2910 OHMS

**DR994B** 1M 40W 220V

**DR994B-200** 2M 80W 240V

**DR994B-2005** 5M 200W 240V

**DR994B-60W** 1.5M 60W 220V

**DR994C** 2M 80W 220V

**DR994D** 3M 120W 240V

**DR994E** 4M 160W 220V

### GLASS DEFROST HEATERS



**GE310** GE 220V

**GE311** GE 110V



**GH.WR2** GE 2 LONG 600W 240V 31CM

**GH.WR3** GE 3 SHORT 600W 240V 24CM



**RF172** WHIRLPOOL 220V 115W 31cm



**RF173A** 8" 220V 100W 20CM

**RF173** 10" 220V 115W 25CM

**RF174** 12" 220V 130W 30CM

**RF174A** 13" 220V 130W

**RF175** 14" 220V 145W 35CM

**RF176** 16" 220V 180W 40CM

**RF176A** 18" 220V

**RF176B** 20" 220V 180W 51CM

**RF176C** 22" 220V 180W 56CM



**RF186** 150W 240V 32CM



**RF187** GE 130W 220V 45CM



**RF189** WHIRLPOOL GLASS HEATER 130W 37cm



**SH-264C** MAYTAG/OTHER 24CM 220V 500W 2-BANK

**SH-265C** MAYTAG/GE 9 1/2" 220V 550W 2-BANK



**T036A** ALUMINIUM STRIPS

### REVERSING VALVES



**RF625** 6TON CAPACITY, ALL GAS V6-412084-11L

**RF624** 3TON CAPACITY, ALL GAS V3-410084-71L

**RF623** 2TON CAPACITY, ALL GAS V2-408064-21L

**RF626** V6-414084-11L

**RF2200** REVERSING VALVE 1.25 TON 5/16" & 3/8"

**RF2201** REVERSING VALVE 2TON 1/2" & 3/8"

**RF2202** REVERSING VALVE 2TON 5/8" & 3/8"

**RF2203** REVERSING VALVE 3TON 5/8" & 1/2"

**RF2204** REVERSING VALVE 6TON 3/4" & 1/2"

**RF2205** REVERSING VALVE 6TON 7/8" & 1/2"

**RF2206** REVERSING VALVE 10TON 7/8" & 1/2"

**RF2207** REVERSING VALVE 10TON 7/8" & 3/4"

**RF2208** REVERSING VALVE 10TON 1 1/8" & 7/8"

**RF2209** REVERSING VALVE COIL 240VAC

REFRIGERATION THERMOSTATS



- FP878563P Q6827 F&P
- FP878360P Q6821 F&P
- FP878259 Q6825 F&P



- RF083B VF3 RANCO FREEZER BARE
- RF086 VS5 RANCO FREEZER WITH ON RISE SIGNAL
- RF086A VS5 SEI FREEZER WITH ON RISE SIGNAL



- RF130B RANCO BARE CYCLIC DEFROST
- RF130 CYCLIC DEFROST KIT P4913
- RF090 FROST FREE JAP/KOR FRIDGE -15 to +3.4°



RF088 FROST FREE WESTINGHOUSE



- RF087 FROST FREE K50-P6084 FITS ALL FRIDGES
- RF087A UNIVERSAL BOTTOM OF FREEZER K50-P6123



RF092 FROST FREE JAP/KOR FREEZER -23 to -17.1°



- RF080 RANCO VA-2 ABSORPTION FROST FREE
- RF080A SEI VA-2 ABSORPTION FROST FREE



RF089 VB-7 RANCO BOTTLE COOLER



RF165 FREEZER PIGS TAIL ASIAN MODEL



- RF081 RANCO VC1 SINGLE DOOR KIT
- RF081A SEI VC1 SINGLE DOOR KIT
- RF081B RANCO VC1 THERMOSTAT BARE
- RF082 VT9 RANCO KIT 2 DOOR CYCLIC DEFROST



RF089A VB-7 SEI BOTTLE COOLER



RF165A FREEZER PIGS TAIL ASIAN MODEL



- RF082A VT9A SEI 2 DOOR CYCLIC DEFROST
- RF082B BARE VK9 RANCO BAG K59-L1102
- RF083 VF3 RANCO FREEZER BARE
- RF083A VF3 SEI FREEZER KIT



RF130KIT CYCLIC DEFROST KIT P4913 W/ KNOB & PLATE

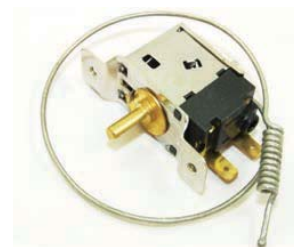

RF168 WATER/DISPENSE GENERIC KIT

Go to  
**stareast.com.au**  
 For up to date products  
 offered and regular new  
 products updates





**RF150** COMMERCIAL ADJUSTABLE 35 TO -35



**RF030B** LIGHT SWITCH SQUARE TYPE



**RF171** SWITCH NATIONAL TYPE 3 PIN

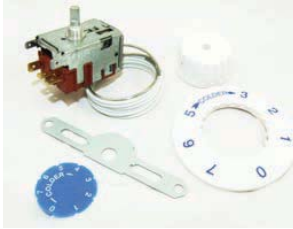

**RF150A** COMMERCIAL WITH SIDE PROBE



**RF146** MULTI PURPOSE SWITCH SQUARE TYPE 3 PIN



**RF171A** SWITCH 3 PIN



**RF150B** COMMERCIAL THERMOSTAT ADJUST 35 TO -35C



**RF060** WHIRLPOOL/SAMSUNG FRIDGE DUAL FAN & LIGHT SWITCH SR-DS04 SSD-6D



**RF027** FROST FREE CUTOUT T/STAT UNIVERSAL

**REFRIGERATION DOOR SWITCHES**

**DEFROST TERMINATIONS**



**RF028** SPST LIGHT SWITCH 2 PIN



**RF061** WHIRLPOOL/SAMSUNG FRIDGE FAN & LIGHT SWITCH 1 BUTTON SSD-5



**RF027A** NEW TYPE CLIP TOP CUTOUT T/STAT UNIVERSAL

**RF029** SPST FAN SWITCH 2 PIN



**RF030** LIGHT & FAN SWITCH 4 PIN



**RF169** 2 BUTTON SWITCH WITH 3 PIN SOCKET



**RF027C** GE FROST FREE T/STAT



**RF030A** LIGHT & FAN SWITCH FLAT TYPE 4 PIN



**RF170** SHARP MULTI PURPOSE SWITCH



**RF027D** BI-METAL ML45

DEFROST TERMINATIONS



RF027E BI-METAL ML50



RF027F BI-METAL ML55

RF027G BI-METAL ML60

RF027H BI-METAL ML65

RF027I BI-METAL ML70



RF027J BI-METAL SL2697 L60-18F



RF027K BI-METAL SL8528 L47-15F



RF027L BI-METAL SL8517 L80-15F



RF027M BI-METAL SL5708 L50-25F

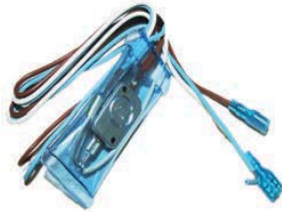

RF144 BI-METAL WITH FUSE



RF144A BI-METAL WITH FUSE



RF145 BI-METAL NO FUSE



RF151 BI-METAL WITH FUSE



RF190 BI-METAL WITH FUSE LG/  
SAMSUNG/WESTINGHOUSE ETC



RF190A PROBE & FUSE SAMSUNG/  
WESTINGHOUSE



RF190B THERMAL FUSE WESTING/  
SAMSUNG 76DC FOIL



RF190C THERMAL FUSE WESTING/  
SAMSUNG 76DC

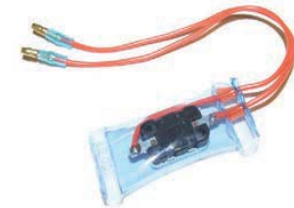

RF190D BI-METAL ST3 LG SAMSUNG ETC

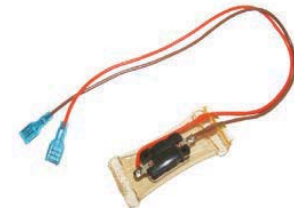

RF190E BI-METAL 350MM  
LG/SAMSUNG



RF190F TH2-13C & FUSE 76C 2 WIRE

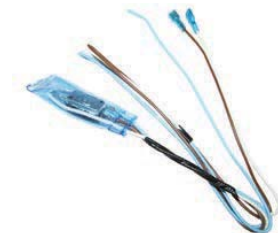

RF190G ST3 & FUSE 72C 3 WIRE  
SAMSUNG



**RF190H** BI-METAL WITH FUSE 3 WIRE MI



**RF190I** ST3 & FUSE 72C 3 WIRE & SOCKET



**RF190J** FUSE & SAFETY THERMO



**RF190K** DEFROST B METAL & FUSE 2 BLUE WIRES



**RF450** COMMERCIAL 5/8 PIPE BLACK

**RF451** COMMERCIAL 5/8 PIPE ORANGE

## GLOBES/LAMPS



**LM002** E14; 15W 300C 240V SES

**LM003** E14; 25W 300C 240V SES

## GLOBES/LAMPS CONTINUED

**LM004** E17; 20W 300C 240V MES

**LM005** E17; 15w 300C 240V MES

**LM006** E27; 25W 240V 300C ES

**LM006A** E27; 25W 240V 300C ES

**LM007** E27; 15W 240V 300C ES

**LM010** E12; 15W 240V 300C TINY SES

**LM011** E17; 15W 240V MES

**LM218** 40W SES 240V LONG TUBULAR

**RF033** E27; 15W ES

**RF034** E14; 15W SES

**RF034A** E14; SMALL NOSE SCREW 15W SLIM SES

**RF035** B22; 15W BC

**RF036** B15; 15W SBC



**WA48121** LAMP SXS REFRIGERATION W'POOL  
3428078

## WATER FILTERS, ICE MAKER VALVES & HOOK-UP KITS

### ICE MAKER KITS



**GE025B** PLASTIC & ACCESS



**DR302** GE 120V GENUINE

**DR302A** GE 220V GENUINE

### WATER FILTERS



**RF204** WF270 CHARCOAL SHORT WITH ACCESSORIES



**RF206** WF271 TASTE & ODOUR REMOVAL



**RF206A** 2500 GALLONS & FITTINGS

**RF206B** 2500 GALLONS PUSH-IN

**RF206C** JUMBO M-CL 10-C



**RF282** GE GSWF 9914 46-9914



**RF284** ELECTROLUX FRRF-100



**RF285** WHIRLPOOL/KITCH/KEN/THERM



**RF286** WHIRLPOOL/PURE/SEARS/KITCH





RF287 GE/HOTPOINT/SEARS/  
KENMORE



RF288 SMEG/MAYTAG/ADMIRAL/AMANA



RF289 MAYTAG/ADMIRAL/SAMSUNG



RF290 LG/ZENITH/SEARS/KENMORE/  
ATAG



RF292A AMANA/MAYTAG/KENMORE



UFK8001 BOTTOM MOUNTS WHIRLPOOL/  
MAYTAG/AMANA

**SPEEDFIT FITTINGS**



RF297 1/4-1/4" ELBOW UNION  
RF297A 1/4-1/4" STRAIGHT UNION

**SPEEDFIT FITTINGS**

- RF297B 3/8-3/8" STRAIGHT UNION
- RF297C 5/16-5/16" STRAIGHT UNION
- RF297D 5/16-5/16" ELBOW UNION
- RF297E 5/16-1/4" STRAIGHT UNION
- RF297F 1/4-3/16" STRAIGHT UNION
- RF297G 1/4" EQUAL TEE
- RF298 1/4x3/4" BSP TAP CONNECTOR
- RF298A 1/4x3/4" BSP CONNECTOR
- RF298B 3/8x3/4" BSP CONNECTOR

**COOLROOM HINGES & LATCHES  
LATCHES**



CT-1178 HEAVY DUTY SAFETY KIT LATCH,  
KEY & FLURO LIGHT



CT-1200 HEAVY DUTY EDMOUNT 18-  
22MM LOCK+KEY



CT-1300 REACH-IN SMLFRZ TRIGGER 18-  
32MM



CT-1400 ROLLER 18-32MM MED-SMALL  
FRIDGE

**HINGES**



CT-1132 CAM LIFT AUTO SELF CLOSING



CT-1238N REVERSIBLE NYLON ASSIST



CT-1238S REVERSIBLE SPRING ASSISTED



CT-1332 EDMOUNT 32MM LEFT/RIGHT

CT-1336 EDMOUNT 36MM ANY DOOR



CT-1428 REACH IN 28MM HEIGHT MED  
FREEZER



CT-1450 REACH IN 32-50MM MED FREEZER

CT-1460 REACH IN 32-60MM BIG FREEZER

CT-1470 REACH IN 40-70MM JUMBO  
FREEZER



## HANDLES



CT-1500 ZINC CHROME PLATED 290MM



CT-1600 DIE CAST 251MM

## CORE TOOLS



T096 DYNATEX GASKET MAKER 108G



T095 20MM HALF SADDLE & 6MM HOLE, PACK OF 50

## OTHER



- RF321 CABLE TIE 5X300 WHITE PKT50
- RF322 CABLE TIE 5X370 WHITE PKT50
- RF323 CABLE TIE 5X380 WHITE PKT50
- RF324 CABLE TIE 8X200 BLACK PKT50
- RF325 CABLE TIE 8X300 BLACK PKT50
- RF326 CABLE TIE 8X400 BLACK PKT50
- RF327 CABLE TIE 8X500 BLACK PKT50
- RF328 CABLE TIE 10X500 BLACK PKT50



RF082INSO INSULATION FOR THERMOSTAT CAPILLARY TUBING



104285 HINGE FOR FRIGDES ALL PURPOSE



RF020 SOLENOID 10W



RF219 COIL, AIR CONDITIONING REVERSE VALVE

**LOOKING FOR INLET VALVES?**  
Go to General Appliance Spares  
(Orange Section)

## MISCELLANEOUS REFRIGERATION & A/C

### ISOLATION SWITCHES



PULWP1/20 SINGLE POLE 20A

PULWP1/35 SINGLE POLE 35A

PULWP3/20 TRIPLE POLE 20A

PULWP3/63A TRIPLE POLE 65A

### WEATHERPROOF POWERPOINTS



RWPP1-10 SINGLE OUTLET 250V

RWPP2-10 DOUBLE OUTLET 250V



RWPP1-16 SINGLE SWITCH 16A/250V

RWPP2-16 DOUBLE SWITCH 16A/250V

### CIRCUIT BREAKERS



SE166 STEP DOWN TRANSFORMER & BASE 240-120V

## CIRCUIT BREAKERS



SE166A	C16 CDSB1-63
SE166B	C20 CDSB1-63
SE166C	C25 CDSB1-63
SE166D	C32 CDSB1-63



SE167	3 PHASE 20A DZ47-63
SE168	3 PHASE 25A DZ47-63
SE169	3 PHASE 32A DZ47-63
SE170	3 PHASE 40A DZ47-63

## SILICONE HEAT TRANSFER COMPOUND

Essential for maintaining a positive seal between the heat sink and the device.

SIL10	10gm
SIL150	150gm

## HEATSINKS



TSSR02-1P	SUIT 1 SSR (REPLACES HS-1)
TSSR02-2P	SUIT 2 SSR (REPLACES HS-2)
TSSR02-3P	SUIT 3 SSR (REPLACES HS-3)
TSSR03	DIN RAIL MOUNTING CLIP TO SUIT HEATSINK
TSSR04	HEAT CONDUCTION RUBBER PAD

## LIMIT SWITCHES

### 5A SEMI-INDUSTRIAL IP65

Metal body (28mm wide). Dust and drip proof construction. Easy to wire conduit entry design.

TZ8104	NON ADJUSTABLE ROLLER LEVER
TZ8107	ADJUSTABLE ROD LEVER
TZ8108	ADJUSTABLE ROLLER LEVER
TZ8111	BUTTON PLUNGER
TZ8112	ROLLER BUTTON PLUNGER
TZ8122	CROSS BUTTON PLUNGER
TZ8166	PLASTIC ROD LEVER
TZ8167	SPRING WIRE LEVER
TZ8168	COIL SPRING LEVER
TZ8169	CATS WHISKER LEVER

## 5A REINFORCED PLASTIC IP65

Plastic body (31mm wide). Glass reinforced plastic. Dust and drip proof construction.

TZ9204	NON ADJUSTABLE ROLLER LEVER
TZ9207	ADJUSTABLE ROD LEVER
TZ9208	ADJUSTABLE ROLLER LEVER
TZ9211	BUTTON PLUNGER
TZ9212	ROLLER BUTTON PLUNGER
TZ9222	CROSS BUTTON PLUNGER
TZ9224	PLASTIC ROD LEVER
TZ9266	SPRING WIRE LEVER
TZ9267	COIL SPRING LEVER
TZ9269	CATS WHISKER LEVER

## TIME CLOCKS

### DIGITAL, DIN MOUNT

EUR-DH48S-S	TWIN TIMER 1S-99MIN 100-240VAC/DC
EUR15A	7 DAY DIGITAL TIME CLOCK SPDT 16A AC1 RATED
PET010	240VAC 1 CHANNEL DIN RAIL MOUNT 7 DAY 24 HR
TM-848-12VDC	12VDC 1 CHANNEL DIN RAIL MOUNT 7 DAY
AHC-812	2 CHANNEL DIGITAL TIME CLOCK 7 DAY 24HR RESERVE 16A

### ANALOGUE, PANEL & DIN MOUNT



TB370	240VAC 24HR DIN
49983	240V 24HR 2 CHANNEL PANEL
AH711	240VAC 24HR DIN WITH 70HR BATTERY BACKUP 30MIN INCREMENTS
SUL180A	COMPACT 240VAC 24HR WITH 70HR BATTERY BACKUP 15MIN INCREMENTS
SUL181H	240VAC 24HR WITH 150HR BATTERY BACKUP MCB PROFILE

## ELECTRO MECHANICAL PANEL MOUNT



MT05	0-5MIN N/O
MT015	0-15MIN N/O
MT030	0-30MIN N/O
MT060	0-60MIN N/O
MT0120	0-120MIN N/O

## BOXCO ENCLOSURES

ABS - Grey body, grey screwed cover IP66

AGS050604	50(H) X 65(W) X 45(D) 0506S
AGS050605	50(H) X 65(W) X 55(D) 0506S
AGS060905	65(H) X 95(W) X 55(D) 0609S
AGS071005	75(H) X 105(W) X 55(D) 0710S
AGS080806	80(H) X 80(W) X 60(D) 0808S
AGS081104	80(H) X 110(W) X 45(D) 0811P
AGS081107	80(H) X 110(W) X 70(D) 0811P
AGS081108	80(H) X 110(W) X 85(D) 0811P
AGS081307	80(H) X 130(W) X 70(D) 0813P
AGS081308	80(H) X 130(W) X 85(D) 0813P
AGS081605	80(H) X 160(W) X 55(D) 0816P
AGS081608	80(H) X 160(W) X 85(D) 0816P
AGS081807	80(H) X 180(W) X 70(D) 0818P
AGS081808	80(H) X 180(W) X 85(D) 0818P
AGS082507	80(H) X 250(W) X 70(D) 0825P
AGS082508	80(H) X 250(W) X 85(D) 0825P
AGS101007	100(H) X 100(W) X 75(D) 1010P
AGS101010	100(H) X 100(W) X 100(D) 1010P
AGS101807	100(H) X 185(W) X 70(D) 1018P
AGS102007	100(H) X 200(W) X 70(D) 1020P
AGS102307	100(H) X 230(W) X 70(D) 1023P
AGS121207	125(H) X 125(W) X 75(D) 1212P
AGS121210	125(H) X 125(W) X 100(D) 1212P
AGS121707	125(H) X 175(W) X 75(D) 1217P
AGS121710	125(H) X 175(W) X 100(D) 1217P
AGS141709	140(H) X 170(W) X 95(D) 1417P
AGS152309	140(H) X 230(W) X 95(D) 1423P
AGS151507	150(H) X 150(W) X 75(D) 1515P
AGS151510	150(H) X 150(W) X 100(D) 1515P
AGS152007	150(H) X 200(W) X 75(D) 1520P
AGS152010	150(H) X 200(W) X 100(D) 1520P
AGS152013	150(H) X 200(W) X 130(D) 1520P
AGS152016	150(H) X 200(W) X 160(D) 1520P
AGS152510	150(H) X 250(W) X 100(D) 1525P
AGS152513	150(H) X 250(W) X 130(D) 1525P
AGS161607	160(H) X 160(W) X 70(D) 1616P
AGS202010	200(H) X 200(W) X 100(D) 2020P
AGS202016	200(H) X 200(W) X 160(D) 2020P
AGS191913	190(H) X 190(W) X 120(D) 1919P

## BOXCO ENCLOSURES CONTINUED

AGS192813	190(H) X 280(W) X 130(D) 1928P
AGS192818	190(H) X 280(W) X 180(D) 1928P
AGS193813	190(H) X 380(W) X 130(D) 1938P
AGS193818	190(H) X 380(W) X 180(D) 1938P
AGS282813	280(H) X 280(W) X 130(D) 2828P
AGS283413	280(H) X 340(W) X 130(D) 2834P
AGS283813	280(H) X 380(W) X 130(D) 2838P
AGS283818	280(H) X 380(W) X 180(D) 2838P
AGS285613	280(H) X 560(W) X 130(D) 2856S
AGS334318	330(H) X 430(W) X 180(D) 3343P
AGS385618	380(H) X 560(W) X 180(D) 3856S

## SQUARE & FLAT PIN WITH LED & TEST BUTTON

BLY2	2 POLE 10A 8 PIN
BMY2	2 POLE 5A 8 PIN
BMY4	4 POLE 5A 14 PIN
TLY2	2 POLE 10A 8 PIN
TMY4	4 POLE 5A 14 PIN

## BASES TO SUIT SQUARE & FLAT PIN RELAYS



PTF-08A	2 POLE 10A 8 PIN
PTF-08I	2 POLE 10A (IZUMI) 8 PIN
PYF-08A	2 POLE 5A 8 PIN
PYF-14A	4 POLE 5A 14 PIN
NDSQ-14	4 POLE 5A (IZUMI) 14 PIN
RT704	4 POLE 5A 14 PIN

## ROUND PIN RELAYS WITH LED & TEST BUTTON

BMK2P	2 POLE 10A 8 PIN
BMK3P	3 POLE 10A 11 PIN
TMK2P	2 POLE 10A 8 PIN
TMK3P	3 POLE 10A 11 PIN

## BASES TO SUIT ROUND PIN RELAYS

PF-083A-E	2 POLE 8 PIN
PF-113A-E	3 POLE 11 PIN

## HEAVY DUTY RELAYS

HF-116F-2/240	240V AC 30A 3HP RATED SPST
HF-116F-2/24A	24V AC 25A 2HP RATED DPST
692/240A5	20A 240V DPDT 2.5HP HEAVY DUTY
692/024A6	20A 240V DPDT 2.5HP HEAVY DUTY

## PHASE FAIL RELAYS

EUR-RSTB	PHASE FAIL/PHASE SEQUENCE RELAY
----------	---------------------------------

## SOCKET OUTLETS

All GEN3 products have Australian / NZ approvals and compliance certificates. All switched sockets include mounting templates and all plugs are complete with compression glands.

### TO 50A - GREY

CO1PH10	3 FLAT PIN 10A 250V
CO1PH15	3 FLAT PIN 15A 250V
CO1PH320R	3 ROUND PIN 20A 250V
CO1PH332R	3 ROUND PIN 32A 250V
CO3PH410	4 ROUND PIN 10A 440V
CO3PH420	4 ROUND PIN 20A 440V
CO3PH432	4 ROUND PIN 32A 440V
CO3PH440	4 ROUND PIN 40A 440V
CO3PH450	4 ROUND PIN 50A 440V
CO3PH510	5 ROUND PIN 10A 440V
CO3PH520	5 ROUND PIN 20A 440V
CO3PH532	5 ROUND PIN 32A 440V
CO3PH540	5 ROUND PIN 40A 440V
CO3PH550	5 ROUND PIN 50A 440V

### TO 50A - RESISTANCE ORANGE

CO1PH10/RO	3 FLAT PIN 10A 250V
CO1PH15/RO	3 FLAT PIN 15A 250V
CO1PH320R/RO	3 ROUND PIN 20A 250V
CO1PH332R/RO	3 ROUND PIN 32A 250V
CO3PH410/RO	4 ROUND PIN 10A 440V
CO3PH420/RO	4 ROUND PIN 20A 440V
CO3PH432/RO	4 ROUND PIN 32A 440V
CO3PH440/RO	4 ROUND PIN 40A 440V
CO3PH450/RO	4 ROUND PIN 50A 440V
CO3PH510/RO	5 ROUND PIN 10A 440V
CO3PH520/RO	5 ROUND PIN 20A 440V
CO3PH532/RO	5 ROUND PIN 32A 440V
CO3PH540/RO	5 ROUND PIN 40A 440V
CO3PH550/RO	5 ROUND PIN 50A 440V

## 2 & 3 PHASE SWITCHES TO 63A

S2P10	2 POLE 10A SWITCH
S2P20	2 POLE 20A SWITCH
S3P20	3 POLE 20A SWITCH
S3P32	3 POLE 32A SWITCH
S3P50	3 POLE 50A SWITCH
S3P63	3 POLE 63A SWITCH

## PLUGS AND SOCKETS

### 1 PHASE & 3 PHASE STRAIGHT PLUGS

PL1PH10	3 FLAT PIN 10A 250V
PL1PH15	3 FLAT PIN 15A 250V
PLSR320	3 ROUND PIN 20A 250V
PLSR332	3 ROUND PIN 32A 250V
PLS3PH410	4 ROUND PIN 10A 440V
PLS3PH420	4 ROUND PIN 20A 440V
PLS3PH432	4 ROUND PIN 32A 440V
PLS3PH440	4 ROUND PIN 40A 440V
PLS3PH450	4 ROUND PIN 50A 440V
PLS3PH510	5 ROUND PIN 10A 440V
PLS3PH520	5 ROUND PIN 20A 440V
PLS3PH532	5 ROUND PIN 32A 440V
PLSPPH440	5 ROUND PIN 40A 440V
PLS3PH550	5 ROUND PIN 50A 440V

### 1 PHASE & 3 PHASE ANGLED PLUGS

PLA3PH410	4 ROUND PIN 10A 440V
PLA3PH420	4 ROUND PIN 20A 440V
PLA3PH432	4 ROUND PIN 32A 440V
PLA3PH440	4 ROUND PIN 40A 440V
PLA3PH450	4 ROUND PIN 50A 440V
PLA3PH510	5 ROUND PIN 10A 440V
PLA3PH520	5 ROUND PIN 20A 440V
PLA3PH532	5 ROUND PIN 32A 440V
PLAPPH440	5 ROUND PIN 40A 440V
PLA3PH550	5 ROUND PIN 50A 440V

### 1 PHASE & 3 PHASE EXTENSION SOCKETS

SCO1P10	3 FLAT PIN 10A 250V
SCO1P15	3 FLAT PIN 15A 250V
SCO1P20R	3 ROUND PIN 20A 250V
SCO1P32R	3 ROUND PIN 32A 250V
SCO4P10	4 ROUND PIN 10A 440V
SCO4P20	4 ROUND PIN 20A 440V
SCO4P32	4 ROUND PIN 32A 440V
SCO4P40	4 ROUND PIN 40A 440V
SCO4P50	4 ROUND PIN 50A 440V
SCO5P10	5 ROUND PIN 10A 440V
SCO5P20	5 ROUND PIN 20A 440V
SCO5P32	5 ROUND PIN 32A 440V
SCO5P40	5 ROUND PIN 40A 440V
SCO5P50	5 ROUND PIN 50A 440V

## GEWISS FLOOR BOXES

Come complete with metal mounting boxes, suitable for use when doing formwork preparation. Suitable where power and data outlets are required away from the wall cavity. TEND LED work lights, 50,000 hours minimum service life. 100mm OD light diameter. 6,000 lum.min/50cm. 12Watts. IP65 rated. Available in 60-290VAC or 6-30VAC.

THL10-LW2S	PIVOTAL ARM 90-260VAC
THL10-LW2M	MED. STEM ARM 90-260VAC
THL10-LW2L	LONG STEM ARM 90-260VAC
THL10-LW7S	PIVOTAL ARM 6-30VAC/DC
THL10-LW7M	MED STEM ARM 6-30VAC/DC
THL10-LW7L	LONG STEM ARM 6-30VAC/DC

**DELTA E SERIES SPEED DRIVES**

Motor power up to 2.2kW 1 ph and 22kW 3 ph. Sensorless vector or V/F control. Removable keypad and potentiometer. Built in PLC with optional I/O and encoder modules. Process follower 0-10V, 4-20mA (optional PTC input). Optional fieldbus modules. DC bus sharing. PID feedback control. RS-485 (MODBUS). C-Tick approved, CE approvals. Built-in filter and brake chopper.

**VFD-E SERIES 240V 1PH/3PH BUILT-IN FILTER WITHOUT KEYPAD**

VFD002E21A	0.18KW
VFD004E21T	0.37KW
VFD007E21T	0.75KW
VFD015E21A	1.5KW
VFD022E21A	2.2KW

**VFD-E SERIES 415V 3PH/3PH BUILT-IN FILTER WITHOUT KEYPAD**

VFD004E43T	0.37KW
VFD007E43T	0.75KW
VFD015E43T	1.5KW
VFD022E43A	2.2KW
VFD037E43A	3.7KW
VFD055E43A	5.5KW
VFD075E43A	7.5KW
VFD110E43A	11KW
VFD150E43A	15KW
VFD185E43A	18.5KW
VFD220E43A	22KW

**VFD-EL ACCESSORIES**

KPELE02	KEYPAD (VFD-E ONLY)
CME-DN01	DEVICENET MODULE
CME-COP01	CANOPEN MODULE
CME-PB01	PROFIBUS MODULE
CME-USB01	USB V1.1 INTERFACE CARD
CME-LW01	LONWORKS MODULE
EME-R2CA	RELAY MODULE 2 X C/O CONTACTS (VFD-E ONLY)
EME-R3AA	RELAY MODULE 3 X C/O CONTACTS (VFD-E ONLY)
EME-D33A	I/O MODULE 3 IN/3 OUT (VFD-E ONLY)
EME-A22A	ANALOGUE I/O CARD 2 IN/2 OUT (VFD-E ONLY)
EME-A1D3A	ANALOGUE I/O CARD 1 IN/3 OUT (VFD-E ONLY)
EME-PG01	ENCODER INPUT CARD (VFD-E ONLY)
BUE-20015	BRAKE MODULE 0.2-1.5kW 240V 1PH
BUE-20037	BRAKE MODULE 2.2kW 240V 1PH
BUE-40015	BRAKE MODULE 0.4-1.5kW 440V 3PH
BUE-40037	BRAKE MODULE 3.7kW 440V 3PH
MKEL-DRA	DIN RAIL ADAPTOR EL SERIES FRAME A
MKEL-DRB	DIN RAIL ADAPTOR EL SERIES FRAME B
MKE-HUB01	RS-485 COMMUNICATION MODULE FOR SERIAL
MKE-EP	EMC EARTHING STRAP

UT528	DIGITAL EARTH LEAKAGE APPLIANCE TESTER
UT15C	AC/DC MULTI FUNCTION VOLTAGE TESTER
UT391	LASER DISTANCE METER

UT372	DIGITAL LASER TACHOMETER NON-CONTACT
UT301C	INFRARED LASER THERMOMETER -18 ~ 550°C
UT303C	INFRARED LASER THERMOMETER -18 ~ 1050°C
UT203	DIGITAL CLAMP METER AUTO RANGE AC/DC AMPS
UT10A	POCKET SIZE DIGITAL MULTIMETER AUTO RANGING
UT33A	DIGITAL MULTIMETER AUTO RANGING
UT60B	DIGITAL MULTIMETER AUTO RANGING MULTI FUNCTION

**BELLS**

4BL-24	24VAC 4" ELECTRIC
4BL-24D	24VDC 4" ELECTRIC
4BL-220	240V 4" ELECTRIC
6BL-12D	12VDC 6" ELECTRIC
6BL-24	24VAC 6" ELECTRIC
6BL-24D	24VDC 6" ELECTRIC
6BL-240	240V 6" ELECTRIC
8BL-24D	24VDC 8" ELECTRIC
8BL-240	240V 8" ELECTRIC
10BL-24D	24VDC 10" ELECTRIC
10BL-240	240V 10" ELECTRIC
41349	240V 4" RED LEGRAND
41419	240V 6" GREY LEGRAND
CBBBX4	IP66 BACK JUNCTION BOX TO SUIT 6", 8" 10" BELLS

**BUZZERS**

TBY-302	240V PANEL MOUNT
TBY-312D	12VDC PANEL MOUNT
TBY-324	24VAC PANEL MOUNT
TBY-324D	24VDC PANEL MOUNT
TBY-24	24VAC FLUSH MOUNT
TBY-24D	24VDC FLUSH MOUNT
TBY-220	240V FLUSH MOUNT
TBN-12	12VAC SURFACE MOUNT
TBN-12D	12VDC SURFACE MOUNT
TBN-220	240V SURFACE MOUNT
TBN-24	24VAC SURFACE MOUNT
TBN-24D	24VDC SURFACE MOUNT

**SIRENS**

TSA-24D	24VDC PLASTIC SURFACE MOUNT 105DB
TSA-220	240V PLASTIC SURFACE MOUNT 105DB
TSC-12D	12VDC METAL SURFACE MOUNT 100DB
TSC-220	240V METAL SURFACE MOUNT 100DB
TSD-12D	12VDC METAL SURFACE MOUNT 120DB
TSD-220	240V METAL SURFACE MOUNT 120DB

**STROBE LIGHTS**





Weatherproof construction IP44. Powerful xenon tube ensures high visibility. Available in red, amber, green and blue.

<b>DL152</b>	12-30VDC MULTI VOLTAGE DOUBLE FLASH 147X120MM
<b>SYF75D-12</b>	12VDC STROBE 80X75MM 76FPM
<b>SYF75D-24</b>	24VDC STROBE 80X75MM 76FPM
<b>SYF75D-240</b>	240V STROBE 80X75MM 70FPM
<b>SYF100-12</b>	12VDC STROBE 100X80MM 76FPM
<b>SYF100-24</b>	24VDC STROBE 100X80MM 76FPM
<b>SYF100-240</b>	240V STROBE 100X80MM 70FPM
<b>SYF130-12</b>	12VDC STROBE 128X95MM 76FPM
<b>SYF130-24</b>	24VDC STROBE 128X95MM 76FPM
<b>SYF130-240</b>	240V STROBE 128X95MM 70FPM
<b>SYF150-240</b>	240V STROBE 147X120MM 70FPM
<b>SYF151D</b>	12-100VDC 30-60VAC STROBE 147X120MM 75FPM
<b>SYF205</b>	12-48VDC MULTI FUNCTION DOUBLE FLASH 140X115MM

## WIRE GUARDS



<b>8038FG</b>	FINGER GUARD TO SUIT 80X80MM FAN
<b>9225FG</b>	FINGER GUARD TO SUIT 92X92MM FAN
<b>12038FG</b>	FINGER GUARD TO SUIT 120X120MM FAN
<b>17258FG</b>	FINGER GUARD TO SUIT 172X150MM FAN
<b>G205</b>	WIRE GUARD TO SUIT 205MM FAN

## TEND ISOLATORS

IP65 with lockable handle. Surface or enclosed mount. Unique shaft removable system.

<b>TDS33-FRR</b>	33A PANEL MOUNT 3 POLE
<b>TDS66-FRR</b>	66A PANEL MOUNT 3 POLE
<b>TDS80-FRR</b>	80A PANEL MOUNT 3 POLE
<b>TDS33-BRR3</b>	32A BASE MOUNT 3 POLE
<b>TDS66-BRR3</b>	66A BASE MOUNT 3 POLE
<b>TDS80-BRR3</b>	80A BASE MOUNT 3 POLE
<b>TDS33-ERR</b>	32A ENCLOSED MOUNT 3 POLE
<b>TDS66-ERR</b>	66A ENCLOSED MOUNT 3 POLE
<b>TDS80-ERR</b>	80A ENCLOSED MOUNT 3 POLE
<b>TDS433-FRR</b>	32A PANEL MOUNT 4 POLE
<b>TDS440-FRR</b>	40A PANEL MOUNT 4 POLE
<b>TDS466-FRR</b>	66A PANEL MOUNT 4 POLE
<b>TDS480-FRR</b>	80A PANEL MOUNT 4 POLE
<b>TDS433-BRR3</b>	32A BASE MOUNT 4 POLE
<b>TDS440-BRR3</b>	40A BASE MOUNT 4 POLE
<b>TDS466-BRR3</b>	66A BASE MOUNT 4 POLE
<b>TDS480-BRR3</b>	80A BASE MOUNT 4 POLE

## FANS

Aluminium black housing. -20°C - +80°C

<b>F2E-80S-230</b>	80X80X38MM AXIAL FAN 240VAC
<b>F2E-92S-230</b>	92X92X25MM AXIAL FAN 240VAC
<b>F2E-120S-24</b>	120X120X38MM AXIAL FAN 24VAC
<b>F2E-120S-115</b>	120X120X38MM AXIAL FAN 115VAC
<b>F2E-120-230</b>	120X120X38MM AXIAL FAN 240VAC
<b>F2E-150S-115</b>	172X150X51MM AXIAL FAN 115VAC
<b>F2E-150S-230</b>	172X150X51MM AXIAL FAN 240VAC

## THERMOSTATS - DIN MOUNTED

<b>JWT6011NC</b>	HEATING THERMOSTAT 0-60°C WITH 1 N/C
<b>JWT6011NO</b>	COOLING THERMOSTAT 0-60°C WITH 1 N/O
<b>JWT6012</b>	HEATING/COOLING THERMOSTAT 0-60°C WITH 1 N/O & 1 N/C
<b>JWT6013</b>	MECHANICAL HYGROSTAT 35-95%

## HEATERS - DIN MOUNTED



<b>JRQ30W</b>	30W 110/250VAC ENCLOSURE HEATER SELF LIMITING
<b>JRQ60W</b>	60W 110/250VAC ENCLOSURE HEATER SELF LIMITING
<b>JRQ100W</b>	100W 110/250VAC ENCLOSURE HEATER SELF LIMITING

## PORCELAIN TERMINAL BLOCKS



<b>B1012</b>	10A 1 WIRE 22X12X16
<b>B3012</b>	30A 1 WIRE 29X18X21
<b>B6012</b>	60A 1 WIRE 32X19X21
<b>B1025</b>	10A 2 WIRE WITH MOUNT HOLE 23X19X18
<b>B1525</b>	15A 2 WIRE WITH MOUNT HOLE 32X23X21
<b>B3025</b>	30A 2 WIRE WITH MOUNT HOLE 34X29X21
<b>B1038</b>	10A 3 WIRE WITH MOUNT HOLE 39X19X17
<b>B1538</b>	15A 3 WIRE WITH MOUNT HOLE 54X24X20
<b>B3038</b>	30A 3 WIRE WITH MOUNT HOLE 52X29X22
<b>B05410</b>	10A 4 WIRE WITH MOUNT HOLE 57X19X15

## NYLON CABLE GLANDS



<b>M12</b>	4-6MM 100PK
<b>M16</b>	5-10MM 50PK
<b>M20</b>	10-14MM 40PK
<b>M25</b>	13-18MM 20PK
<b>M32</b>	18-25MM 15PK
<b>M40</b>	22-32MM 6PK
<b>M50</b>	30-38MM 3PK
<b>M63</b>	34-44MM 2PK
<b>MX3-125</b>	125ML INOX LUBRICANT FOOD GRADE
<b>MX3-100</b>	100G INOX LUBRICANT FOOD GRADE
<b>MX3-300G</b>	300G INOX LUBRICANT FOOD GRADE
<b>MX4-300</b>	300G LANOX LUBRICANT
<b>MX4G-500</b>	500G LANOX LUBRICANT FOOD GRADE
<b>MX5-300</b>	300G INOX PTFE LUBRICANT FOOD GRADE
<b>MX2-92</b>	92ML BATTERY CONDITIONER
<b>MX7-125</b>	125G PTFE ASSEMBLY TUBE TUBE
<b>MX8-450</b>	450G INOX PTFE GREASE
<b>MX8-500</b>	500G INOX PTFE GREASE TUB
<b>MX6-30</b>	30G INOX FOOD GRADE GREASE TUBE
<b>MX6-400</b>	400G INOX FOOD GRADE GREASE CART

AN EXAMPLE OF STAREASTS TECHNICAL DATA

AFER-350 Series Axial Fan Motors



- Material: Grid: Steel, Surface treatment and coated with black plastic or paint.
- Wall ring: Sheet steel, Surface treatment and coated with black plastic or paint.
- Blades: Sheet steel, Surface treatment and coated with black plastic or paint.
- Rotor: Surface coated with black plastic or paint.
- Number of blades: 5
- Direction of rotation: Clockwise is sucking, counter-clockwise is blowing, seen on rotor.
- Type of protection: IP54
- Insulation class: "B" "F"
- Mounting position: Horizontal or vertical installation
- Mode of operation: Continuous operation
- Bearings: Maintenance-free bearings, L10
- Both single and three phase motors available
- Both 4 and 6 pole motors available

MODEL	NO. ON THE CURVE	VOLTAGE (V)	PHASE (Ø)	FREQUENCY (HZ)	MAX. CURRENT (A)	MAX. POWER INPUT (W)	SPEED (RPM)	NOISE (dBA)	CAPACITOR (µF)	MAX. OPERATIVE RANGE (Pa)	NET WEIGHT (kg)	LICENSE
AFER4D-350	A	415	3~	50	0.38	165	1370	64	-	90	4.8	CCC CE
AFER4E-350	C	240	1~	50	0.62	145	1330	64	4	85	4.8	CCC CE
AFER6D-350	E	415	3~	50	0.29	112	910	53	-	80	4.8	CCC CE
AFER6E-350	G	240	1~	50	0.37	85	870	52	2	70	4.8	CCC CE

Curves

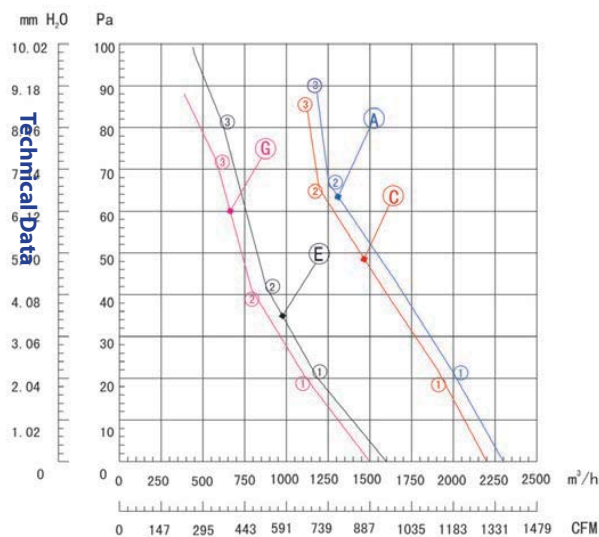

		(RPM)	(W)	(A)	(Pa)
A	①	1400	150	0.36	20
	②	1380	155	0.37	65
	③	1370	165	0.38	90
C	①	1370	125	0.54	20
	②	1350	130	0.57	65
	③	1330	145	0.62	85
E	①	960	82	0.28	20
	②	950	93	0.28	40
	③	910	112	0.29	80
G	①	940	68	0.30	20
	②	920	70	0.31	40
	③	870	85	0.37	70

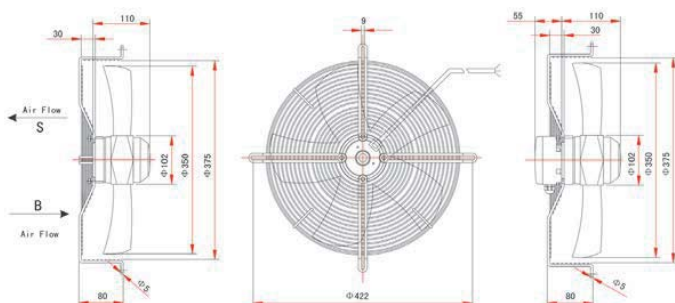

NEED MORE TECHNICAL DATA SHEETS ON OUR PRODUCTS CALL 02 97925988 OR VISIT OUR WEBSITE AND REGISTER ONLINE TO VIEW TECHNICAL DATA SHEETS.